

LITERATURE FOR THE RADIO AMATEUR

The Radio Amateur incorporating Short Wave News. Constructional articles, topical features and news reviews for the radio amateur whether his interest be receiving or transmitting. Annual Sub. 21/-.

R.S.G.B. "G" CALL BOOK. Contains up-to-date names and addresses of some 6,000 licensed amateur stations in the British Isles and Eire. 3/9.

World Radio Valve Handbook. A reference book giving you all data on the most commonly used receiving valves in the world. A copy in your shack will save you much time. 11/9.

World Radio Handbook (1952 edition). The S.W. broadcast enthusiasts handbook. You are missing something from your hobby if you have not a copy of this excellent publication. 8/9.

Inexpensive Television. Build yourself a television from surplus. Latest edition includes all the data on a television for Holme Moss. 2/8.

How to Listen to the World. Another useful little booklet by the publishers of the world famous World Radio Handbook and the World Radio Valve Handbook. Gives the beginner all the information he needs on starting S.W. broadcast listening. 1/8.

Report Pads. If you need that QSL card, send a comprehensive report. A convenient and accurate form for reporting. 3/3.

All above prices include postage and packing.

All available from:—

AMALGAMATED SHORT WAVE PRESS LTD.

57, Maida Vale, Paddington, London, W.9.

RADIO CONSTRUCTOR

for the Radio and Television Enthusiast

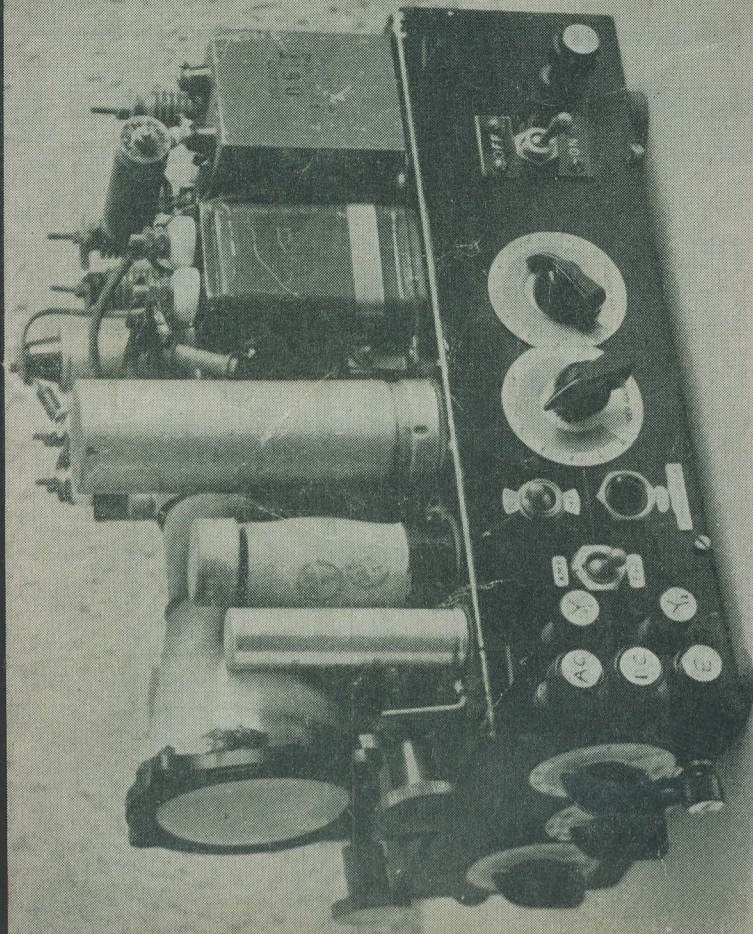

IN THIS ISSUE . . .

THE SCINTILLASCOPE . . . TWO-STAGE TUNING UNIT
AWAY FROM THE "FOUR PLUS ONE" . . . Large Screen
T.V. . . . Radio Control of Models . . . In Your Workshop
Kit Review

etc., etc.

16

IF YOU ARE TIRED

OF USING SECOND RATE COMPONENTS AND

IF YOU'RE BUILDING THE WILLIAMSON

We have in stock all the specified components to make this

Superlative Amplifier

PARTRIDGE MAINS OUTPUT TRANSFORMERS

PARTRIDGE CHOKES

T.C.C. CONDENSERS

HIGH STABILITY RESISTORS, 1% & 5%

PRECISION CONDENSERS, 1%, 2% & 5%

MATCHED VALVES

IN FACT "THE WORKS"

Detailed Price List of all Components available on request.

TELE - RADIO (1943) LTD.,

177, EDGWARE ROAD, LONDON, W.2.

Phone: PAD. 5606
PAD. 6116

Shop Hours:
Mon-Sat. 9 a.m.—6 p.m.
Thursday 9 a.m.—1 p.m.

(Please mention this paper)

ADVANTAGES OF THE

'ENGLISH ELECTRIC'

METAL C.R. TUBES

I. The Face Plate

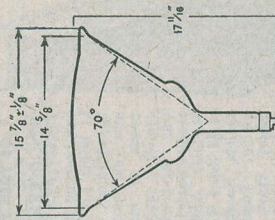

The face plate is one of the most important features of a C.R. tube, for upon the quality of the glass, its degree of curvature and the screen coating, depend the final reproduction of the picture. The use of a metal cone enables the face plate to be manufactured separately, permitting the use of glass of a very high optical quality. The curvature is slight which lessens distortion at the edges, and the picture is presented on a high efficiency white fluorescent screen. A rounded end picture 11" x 14 3/8" is obtained by using the full screen diameter; or a rectangular picture 10" x 13 1/4" within the minimum-useful-screen area.

PRICE £24. 6. 5
Tax Paid

BRITISH MADE BY 'ENGLISH ELECTRIC'

Enquires are also invited for a new 16" tube with short overall length suitable for AC/DC operation with heater volts 6.3 and heater current 0.3 amps.

For full technical details and price for quantities write to:

THE ENGLISH ELECTRIC COMPANY LTD., TELEVISION DEPT., QUEENS HOUSE, KINGSWAY, LONDON, W.C.2

IF YOU ARE TIRED

OF USING SECOND RATE COMPONENTS AND

IF YOU'RE BUILDING THE WILLIAMSON

We have in stock all the specified components to make this

Superlative Amplifier

PARTRIDGE MAINS OUTPUT TRANSFORMERS

PARTRIDGE CHOKES

T.C.C. CONDENSERS

HIGH STABILITY RESISTORS, 1% & 5%

PRECISION CONDENSERS, 1%, 2% & 5%

MATCHED VALVES

IN FACT "THE WORKS"

Detailed Price List of all Components available on request.

TELE - RADIO (1943) LTD.,

177, EDGWARE ROAD, LONDON, W.2.

Phone: PAD. 5606
PAD. 6116

Shop Hours:
Mon-Sat. 9 a.m.—6 p.m.
Thursday 9 a.m.—1 p.m.

(Please mention this paper)

DENCO presents MINIATURE DUAL PURPOSE COILS

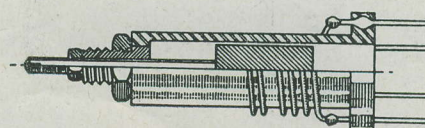

ACTUAL SIZE

- * Each coil can be used for either Chassis Mounting or plugging into a standard Noval (9 pin) Valveholder.
- * Litz windings where required on L.F. ranges.
- * Complete range for Superhet or Straight receivers covering approx. 150 Kcs—78 Mcs.
- * The former and Base are completely moulded in colour coded polystyrene.
- * The following colour code identifies the coils.
BLUE: Grid coil with aerial coupling for winding. For R.F. or Mixer—3/11d. each.
YELLOW: Grid coil with coupling for reaction or R.F. anode. Straight detector or Mixer following R.F.—3/11d. each.
GREEN: Grid coil with reaction and coupling windings (6 pin)—4/9d. each.
RED: Superhet Oscillator 465 Kcs.—3/11d. each.
WHITE: Superhet Oscillator 1.6 Mc/s.—3/11d. each.
(NOTE: Range 6 and 7 Red can be used for various I.F.s: no white coils are made for these ranges).

* Complete technical information on the coils and full instructions for their use is given in our TECHNICAL BULLETIN DTB.4—2/6 each.

RANGE	1	2	3	4	5	6	7
Mc/s.	.150/.400	.515/1.545	1.67/5.3	5/15	10.5/31.5	30/50	45/78
METRES	2000/750	580/194	180/57	60/20	28/9.5	10/6	6.6/3.8

When using a 1.6 Mc. I.F. Range 1 covers .175/.525 Mc. 1700/570m.
Formers of the above coils complete with cores are available in the following colours: 4 pin Blue, Yellow, Red, Clear; 6 pin Green—Price 1/8d. each.

Send for our General Catalogue (Price 1/- post free).

DENCO (Clacton) Ltd., Old Road, Clacton-on-Sea, Essex.

"YOU CAN RELY ON US"

BRIMAR OSRAM MULLARD Valve Manuals 5/- each

SELENIUM RECTIFIERS
 36HT50 — 24/6 New Westinghouse—
 36HT 100-27/10, 14A86-18/3, 14D36-11/-,
 WX3-3/7, WX6-3/7, 36EHT45, 20/6.
LINE CORD 3 WAY
 0.2amp 100Ω per foot—8d. Ft.
 0.3amp 60Ω per foot—8d. Ft.
DROPPERS
 Standard 0.3A 800Ω 5/1-, 0.2A 980Ω 5/1-
 Midgear 6/3 each 2 1/2" high.

SURPLUS VALVES
 Here are a few—write for our "Valve Bargain List" with over 120 types.
 6AG5-9/6, EF50-7/6, 6H6m-4/6, 12A6m-8/7,
 3AA-7/6, 6K6gt-8/6, 30S-8/6, 6J5gt-6/6,
 6SH7 metal-7/6, 6BW6-12/6, 6BE6-18/1-,
 6AT6-10/6, 6BA6-12/6, 50CS13/6.

TUBULAR CONDENSERS
 0.0001, 0.0002, 0.0004, 0.0005, 0.01, 0.1 6d. each.
 0.25μF, 1/- each, 0.5μF, 1/6 each.
MICA CONDENSERS
 0.0001, 0.0002, 0.0003, 0.0005, 0.001, 0.002,
 0.005 6d. each.

VALVE CANS
 3 pieces aluminium. (Octal valves) 1/6 each.
TRIMMERS
 30pF 50pF-9d, 100pF 150pF-1/-, 250pF-1/7-,
 500pF-2/-, 750pF-2/2.

And we sell the "Radio Constructor".
 Write for our 32 page catalogue No. 16
 Price 6d.

RADIO SERVICING COMPANY (Dept. K)
 444, WANDSWORTH ROAD, LONDON, W.8.
 Macaulay 4155.

VOL CONTROLS
 Midgear, with switch, 5/-; less, 3/6; standard
 case 4/3 with switch, 2/9, less.

COILS
 Weymouth CT2W2 9/6 pair, CS3W3 11/9.
 'H' coils 3/6. 'K' coils 4/9. Wearite 'P' coils 3/1-.
 TRF coils matched pair MW/LW/ reaction 7/6.
 Viewmaster, set of coils London 22/-.
 Birmingham 28/-, Holme Moss 30/-.

IF TRANSFORMERS
 All 465 K/cs.—Weymouth P4, 15/- pair.
 Wearite midgear, M800, 21/- pair. R5GB semi-midgear, 12/6 pair.

BASES
 Int. octal, 6d.; Mazda, 6d.; B7G, 1/-; B9A, 1/3; 89C, 9d.; British 4, 5, 7-pin, 6d.; all Amphenol type except British.

SWITCHES
 Midgear type—2 pole 2 way, 2/6; 2 pole 6 way, 3/6; 3 pole 4 way, 3/6; 4 pole 3 way, 3/6; 1 pole 12 way, 3/6; Standard type: 1 pole 18 way 2/6; 6 pole 3 way on two banks, 4/6.

ELECTROLYTICS
 8μF 450v Midgear, 3/-; 8μF Tube wire ended, 3/-; 4μF 350v W/E, 1/6; 16μF 350v, 2/6; 16μF 450v, 4/6; 8-16μF 450v ALI, 5/-; 8-8 2μF 500v ALI, 4/6; 16-24 μF 350v, 6/-; 32μF 450v, 4/9; 25μF 25v, 1/6; 50μF 50v 2/-; 1μF 350v midgear, 2/6; 20μF 12v midgear, 2/6; 10μF 20v, 2/6.

MAX CUTTERS
 Ideal chassis punches—clean hole punched with no effort. Complete with Key:— 1 1/2, 2, 3, 4, 5, 6, 7, 8, 9, 10, 11, 12, 13, 14, 15, 16, 17, 18, 19, 20, 21, 22, 23, 24, 25, 26, 27, 28, 29, 30, 31, 32, 33, 34, 35, 36, 37, 38, 39, 40, 41, 42, 43, 44, 45, 46, 47, 48, 49, 50, 51, 52, 53, 54, 55, 56, 57, 58, 59, 60, 61, 62, 63, 64, 65, 66, 67, 68, 69, 70, 71, 72, 73, 74, 75, 76, 77, 78, 79, 80, 81, 82, 83, 84, 85, 86, 87, 88, 89, 90, 91, 92, 93, 94, 95, 96, 97, 98, 99, 100, 101, 102, 103, 104, 105, 106, 107, 108, 109, 110, 111, 112, 113, 114, 115, 116, 117, 118, 119, 120, 121, 122, 123, 124, 125, 126, 127, 128, 129, 130, 131, 132, 133, 134, 135, 136, 137, 138, 139, 140, 141, 142, 143, 144, 145, 146, 147, 148, 149, 150, 151, 152, 153, 154, 155, 156, 157, 158, 159, 160, 161, 162, 163, 164, 165, 166, 167, 168, 169, 170, 171, 172, 173, 174, 175, 176, 177, 178, 179, 180, 181, 182, 183, 184, 185, 186, 187, 188, 189, 190, 191, 192, 193, 194, 195, 196, 197, 198, 199, 200, 201, 202, 203, 204, 205, 206, 207, 208, 209, 210, 211, 212, 213, 214, 215, 216, 217, 218, 219, 220, 221, 222, 223, 224, 225, 226, 227, 228, 229, 230, 231, 232, 233, 234, 235, 236, 237, 238, 239, 240, 241, 242, 243, 244, 245, 246, 247, 248, 249, 250, 251, 252, 253, 254, 255, 256, 257, 258, 259, 260, 261, 262, 263, 264, 265, 266, 267, 268, 269, 270, 271, 272, 273, 274, 275, 276, 277, 278, 279, 280, 281, 282, 283, 284, 285, 286, 287, 288, 289, 290, 291, 292, 293, 294, 295, 296, 297, 298, 299, 300, 301, 302, 303, 304, 305, 306, 307, 308, 309, 310, 311, 312, 313, 314, 315, 316, 317, 318, 319, 320, 321, 322, 323, 324, 325, 326, 327, 328, 329, 330, 331, 332, 333, 334, 335, 336, 337, 338, 339, 340, 341, 342, 343, 344, 345, 346, 347, 348, 349, 350, 351, 352, 353, 354, 355, 356, 357, 358, 359, 360, 361, 362, 363, 364, 365, 366, 367, 368, 369, 370, 371, 372, 373, 374, 375, 376, 377, 378, 379, 380, 381, 382, 383, 384, 385, 386, 387, 388, 389, 390, 391, 392, 393, 394, 395, 396, 397, 398, 399, 400, 401, 402, 403, 404, 405, 406, 407, 408, 409, 410, 411, 412, 413, 414, 415, 416, 417, 418, 419, 420, 421, 422, 423, 424, 425, 426, 427, 428, 429, 430, 431, 432, 433, 434, 435, 436, 437, 438, 439, 440, 441, 442, 443, 444, 445, 446, 447, 448, 449, 450, 451, 452, 453, 454, 455, 456, 457, 458, 459, 460, 461, 462, 463, 464, 465, 466, 467, 468, 469, 470, 471, 472, 473, 474, 475, 476, 477, 478, 479, 480, 481, 482, 483, 484, 485, 486, 487, 488, 489, 490, 491, 492, 493, 494, 495, 496, 497, 498, 499, 500, 501, 502, 503, 504, 505, 506, 507, 508, 509, 510, 511, 512, 513, 514, 515, 516, 517, 518, 519, 520, 521, 522, 523, 524, 525, 526, 527, 528, 529, 530, 531, 532, 533, 534, 535, 536, 537, 538, 539, 540, 541, 542, 543, 544, 545, 546, 547, 548, 549, 550, 551, 552, 553, 554, 555, 556, 557, 558, 559, 560, 561, 562, 563, 564, 565, 566, 567, 568, 569, 570, 571, 572, 573, 574, 575, 576, 577, 578, 579, 580, 581, 582, 583, 584, 585, 586, 587, 588, 589, 590, 591, 592, 593, 594, 595, 596, 597, 598, 599, 600, 601, 602, 603, 604, 605, 606, 607, 608, 609, 610, 611, 612, 613, 614, 615, 616, 617, 618, 619, 620, 621, 622, 623, 624, 625, 626, 627, 628, 629, 630, 631, 632, 633, 634, 635, 636, 637, 638, 639, 640, 641, 642, 643, 644, 645, 646, 647, 648, 649, 650, 651, 652, 653, 654, 655, 656, 657, 658, 659, 660, 661, 662, 663, 664, 665, 666, 667, 668, 669, 670, 671, 672, 673, 674, 675, 676, 677, 678, 679, 680, 681, 682, 683, 684, 685, 686, 687, 688, 689, 690, 691, 692, 693, 694, 695, 696, 697, 698, 699, 700, 701, 702, 703, 704, 705, 706, 707, 708, 709, 710, 711, 712, 713, 714, 715, 716, 717, 718, 719, 720, 721, 722, 723, 724, 725, 726, 727, 728, 729, 730, 731, 732, 733, 734, 735, 736, 737, 738, 739, 740, 741, 742, 743, 744, 745, 746, 747, 748, 749, 750, 751, 752, 753, 754, 755, 756, 757, 758, 759, 760, 761, 762, 763, 764, 765, 766, 767, 768, 769, 770, 771, 772, 773, 774, 775, 776, 777, 778, 779, 780, 781, 782, 783, 784, 785, 786, 787, 788, 789, 790, 791, 792, 793, 794, 795, 796, 797, 798, 799, 800, 801, 802, 803, 804, 805, 806, 807, 808, 809, 810, 811, 812, 813, 814, 815, 816, 817, 818, 819, 820, 821, 822, 823, 824, 825, 826, 827, 828, 829, 830, 831, 832, 833, 834, 835, 836, 837, 838, 839, 840, 841, 842, 843, 844, 845, 846, 847, 848, 849, 850, 851, 852, 853, 854, 855, 856, 857, 858, 859, 860, 861, 862, 863, 864, 865, 866, 867, 868, 869, 870, 871, 872, 873, 874, 875, 876, 877, 878, 879, 880, 881, 882, 883, 884, 885, 886, 887, 888, 889, 890, 891, 892, 893, 894, 895, 896, 897, 898, 899, 900, 901, 902, 903, 904, 905, 906, 907, 908, 909, 910, 911, 912, 913, 914, 915, 916, 917, 918, 919, 920, 921, 922, 923, 924, 925, 926, 927, 928, 929, 930, 931, 932, 933, 934, 935, 936, 937, 938, 939, 940, 941, 942, 943, 944, 945, 946, 947, 948, 949, 950, 951, 952, 953, 954, 955, 956, 957, 958, 959, 960, 961, 962, 963, 964, 965, 966, 967, 968, 969, 970, 971, 972, 973, 974, 975, 976, 977, 978, 979, 980, 981, 982, 983, 984, 985, 986, 987, 988, 989, 990, 991, 992, 993, 994, 995, 996, 997, 998, 999, 1000.

OPPORTUNITIES IN RADIO

Get this FREE Book!

"ENGINEERING OPPORTUNITIES" reveals how you can become technically qualified at home for a highly paid key appointment in the vast Radio and Television industry. In 144 pages of intensely interesting matter it includes full details of our up-to-the-minute home-study courses in all branches of RADIO AND TELEVISION, A.M. Brit.I.R.E., City and Guilds, Special Television, Servicing, Sound-film Projection, Short Waves, High Frequency and General Wireless Courses.

We definitely guarantee "NO PASS — NO FEE"

If you are earning less than £14 a week this enlightening book is for you. Write for your copy to-day. It will be sent FREE and without obligation. BRITISH INSTITUTE OF ENGINEERING TECHNOLOGY

BIET
 854, Shakespear House,
 17-19 Stratford Place,
 London, W.1.

Radio Constructor
 Vol. 5, No. 8. Annual Subscription 18/- April 1952.
 Editorial and Advertising Offices—57, Maids Vale, Paddington,
 London, W.9.
 Edited by C. W. C. OVERLAND, G2ATV



CONTENTS

Suggested Circuits: A Remote Mains On-Off Control, by G. A. French - - - 290

Radio Control of Models—A Two-Valve Receiver for Radio Control, by A. C. Gee, G2UK- - - 292

In Your Workshop, by J.R.D. - - - 295

The "Scintillascop," by T. H. Robinson, B.Sc. - - - 298

Trade News - - - 305

Query Corner: Two-Stage Tuning Unit - - - 306

Away From the "Four Plus One," Pt. 1, by F. L. Bayliss, A.M.I.E.T. - - - 309

Large Screen TV, Pt. 2 - - - 314

Harmonic Drive, Pt. 6, by P. Turner - - - 317

Kit Review: Premier Magnetic Tape Recording Kit—M.O.S. Amplifier Type A1 - - - 324

"RC QUIZ," conducted by W. Groome - - - 327

Radio Miscellany, by Centre Tap - - - 328

From Our Mailbag - - - 330

SUCCESS

We wonder how many people have been lucky enough to build a television successfully at the first attempt? There are so many variable factors involved that we think most constructors must come up against some trouble sooner or later. We have, therefore, put in hand a publication, to be entitled "TV Fault-Finding," which we feel will meet with a great deal of interest amongst TV fans.

As most faults in television receivers have an effect upon the picture, we have felt that the best way to treat this subject is from a visual aspect—in addition to a large number of illustrations photographed direct from a television screen, showing the most common faults. Fault recognition will be assisted by the fault-finding index at the beginning of the book, and this will be cross-referenced to methods of fault rectification which will be described at greater length in succeeding chapters.

Suggested CIRCUITS for the EXPERIMENTER

The circuits presented in this series have been designed by G. A. FRENCH specially for the enthusiast who needs only a circuit and the essential relevant data.

No. 16: Remote Mains On-Off Control

This month's circuit is designed for switching a mains receiver on and off from a remote position. It uses only two connecting leads, and drain on the energising battery is almost negligible. The two leads could, if desired, be used also for driving an extension loud-speaker.

The Circuit

The basic circuit is shown in Fig. 1. To explain its action, let us assume that the receiver is an AC mains type, using a metal HT rectifier; and that the "remote-local"

switch installed in the receiver is set to "remote." The relay used is of the type having a high resistance coil.

To switch on the receiver, the "On" button at the remote position is pressed. This connects a battery to the relay coil, thus energising it and completing the mains input to the receiver. Owing to the use of a metal rectifier, HT appears almost immediately. This HT voltage is applied, via R, to the relay coil. The value of R and the connections to the energising battery are so chosen that they both apply an equal voltage of the same polarity to the relay coil.

The "On" button is then released, the relay remaining energised by reason of the HT voltage. When it is desired to switch off the receiver, the "Off" button is pressed at the remote position. This short-circuits the coil of the relay, which then de-energises and switches off the receiver. (The resistor R prevents any excessive HT current when the relay coil is short-circuited).

Such is the action of the relay. It will be seen that both buttons have to be pressed for only a very short space of time: the "On" button sufficiently long for an HT voltage to be formed in the receiver, and the "Off" button long enough to allow the HT smoothing capacitors to discharge. However, should a valve instead of a metal rectifier be used in the receiver, it will be necessary to keep the "On" button pressed for a little longer in order to allow it to warm up. This is not too great a disadvantage, as most rectifiers warm up fairly quickly. A directly-heated rectifier (such as the 5Y3) comes into operation almost immediately after the voltage has been applied to its filament. Indirectly-heated valves of the 5Z4 class (in which the cathode is internally connected to one

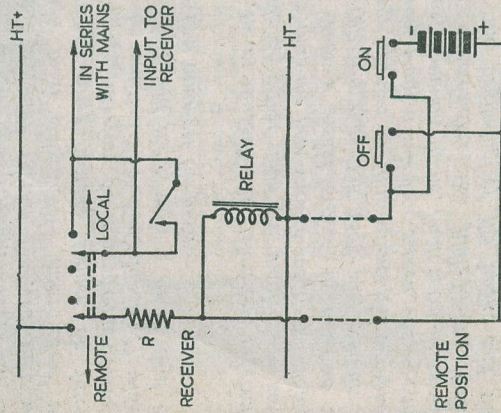

Fig. 1: Basic circuit of the remote control.

side of the heater) do not take much longer. Even a valve like the 6X5 commences to rectify fairly quickly.

Nevertheless, in some cases (particularly with AC/DC receivers), some considerable time can elapse before the rectifier commences to work. It would obviously be a nuisance having to keep the "On" button depressed for this period, and an alternative circuit for the remote position is shown in Fig. 2. In this diagram a switch is used at the remote position and the energising battery is connected all the time that this is switched on. Otherwise the principle is the same as that used in Fig. 1. When the circuit of Fig. 2 is used, care should be taken to see that the value of R is such as to apply a voltage across the relay coil as near to that of the energising battery as is possible. Under these conditions, no discharge from the battery should occur as soon as HT appears in the receiver.

Practical Points

Little needs to be said about the practical applications of the circuit as it is fairly straightforward and self-explanatory. The relay should be of the usual high-resistance type having a coil of about 2,000 Ω resistance. These relays usually close with a minimum energising voltage of about 20 volts or so. Three 9-volt grid bias batteries at the remote point should give an adequate voltage.

The contacts of most P.O. type relays appear usually to be rather small for mains switching; yet they seem to cope quite well in practice! It is a good plan to have two

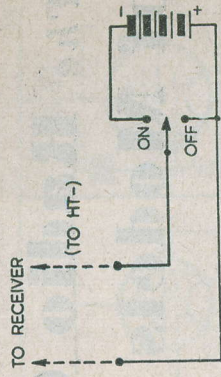

Fig. 2: Alternative circuit for the remote receiver.

sets of contacts in parallel on the one relay; one set "making" just before the other. This set of contacts then bears the brunt of whatever arcing may occur at the moment of switching. A relay of this type could not be used for switching a receiver connected to DC mains.

It should be remembered that, when an AC/DC receiver is being used, the remote wiring may possibly be "live."

If a high impedance extension speaker outlet is used, the speaker wires themselves could be used for controlling the receiver. Should this be done, apart from fitting isolating capacitors, it will also be necessary to use a choke in series with the relay coil in the receiver. A second choke at the remote position will be needed for the circuit of Fig. 2.

Now in Preparation . . .

TV FAULT-FINDING

(DATA BOOK SERIES No. 5)

This is a completely new production—not a reprint—and is unique in that it is lavishly illustrated by photographs taken from the screen of a television exhibiting the faults under discussion. A handy fault-finding index is incorporated, and this is cross-referenced to the book itself.

AMALGAMATED SHORT WAVE PRESS LTD.,
57, MAIDA VALE, LONDON W.9.

Tel.: CUN 6518

The Radio Control of Models . . .

By A. C. GEE, G2UK.

A Two Valve Receiver for Radio Control

So far in this series, we have confined our attention to commercially available R/C gear. The newcomer to this aspect of electronics is strongly advised to gain his initial experience in this way. Once he has gained some experience he can go on to designing and constructing R/C gear to his own requirements, assured that his earlier experience will be a valuable factor in helping him to succeed.

The receiver described herewith makes an excellent unit for the experimenter anxious

to tackle construction. With the exception of the quench coil, which must be wound, all components used are normal ones which, as likely as not, will be found around the workshop. No effort has been made to cut down weight, the receiver being designed and constructed more for the experience gained than anything else, but as can be seen from the photos, it is of sufficiently small size to go into a reasonably small model boat.

A review of the literature concerning

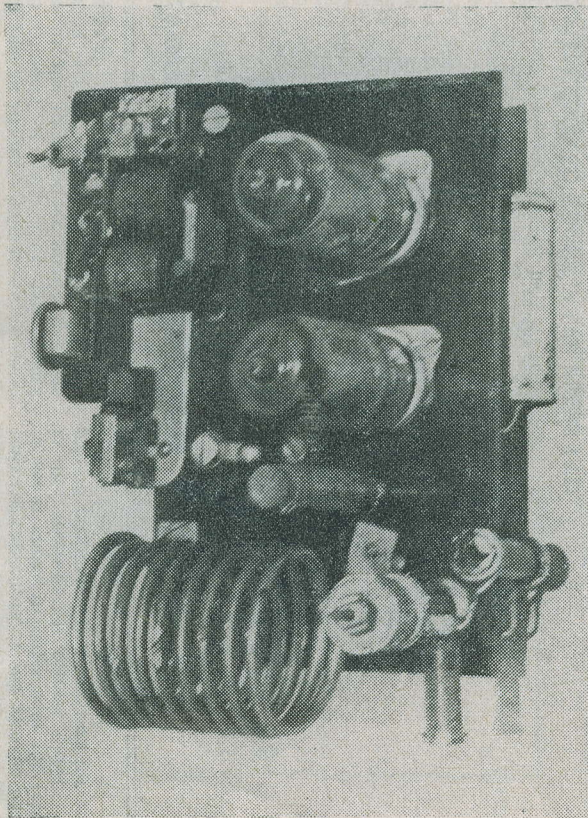

Upper View of Receiver showing Layout of Valves, Tuning Coil and Relay.

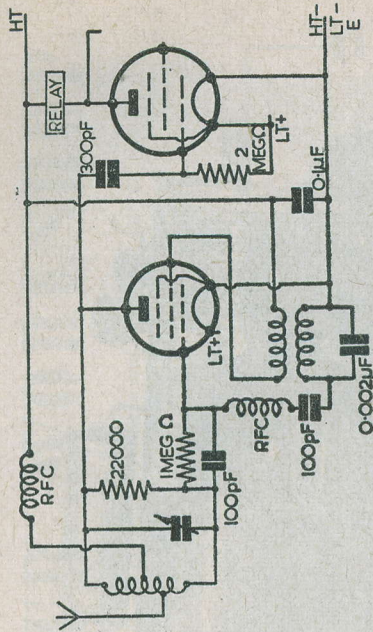

Circuit of 2-Valve Radio Control Receiver.

R/C equipment gave the impression that one could not expect a very great current change from a single valve receiver, that is when using a valve of the 'hard' or vacuum type as opposed to the gas filled triode type, which is used in the commercial equipment so far described. We wished to make use in our experimental receiver of a war surplus relay of the Siemens 73 type. This relay is quite sensitive, but our version required several mA for reliable action. We decided to use two valves, therefore, the first in a super-regenerative circuit and the second as an amplifier. The principle adopted was to use the 'hiss' produced by the super-regen circuit to vary the bias on the second valve. Using a pair of miniature Mullard DL-92s, we were able to get a current change of from 10 mA to 5 mA with 45V HT in the anode circuit of the second valve; more than sufficient to give reliable relay action. It will be noticed that the current change is stated to fall from 10 mA to 5 mA and the reader may wonder—in view of what has been said about the hiss being used to vary the bias on the second valve—why the current falls instead of rising. In practice, it is possible to tune the receiver so that the current change is from low to high, but in this condition of maximum hiss, the first valve is at its least sensitive condition, and it was found better to adjust the first valve so that it is barely super-regenerating. It will then be found that the second valve's plate current drops instead of rises.

The circuit of the receiver is shown herewith and is quite straightforward. The first valve functions as a super-regenerative oscillator and the circuit used is a fairly conventional one. The details of the super-regen coil are as follows:—

A former must be built up to the dimensions shown. Stout cardboard, paxolin tube and sheet or other similar materials can be used. If cardboard or wood is used, dope it well with Denfix cement and leave to dry before winding. Wind on 350 turns of 34 swg enamelled wire into each space. This can easily be done by rigging up a wheel-brace in the vice and mounting the former on a piece of screwed rod between two large washers and nuts. Fix the rod into the chuck of the wheel-brace and see how many revolutions it does for one turn of the handle. Mount the bobbin of wire on a conveniently placed spindle and wind away, counting the turns of the handle as one does so.

The general construction of the receiver can be seen pretty well from the photos. It is built up on a piece of 1/8" thick paxolin sheet, 2 1/2" wide by 4" long. The tuning coil consists of nine turns of 12 swg bare or tinned wire wound so as to be self-supporting, the diameter of the coil being 1 1/4". Solder the ends to two brass bolts and fix by pushing these through holes drilled in the paxolin sheet. Space the turns of the coil so that its overall length is 1 1/2".

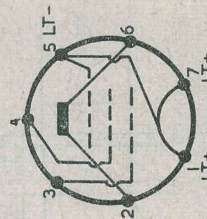

DL-92 BASE CONNECTIONS

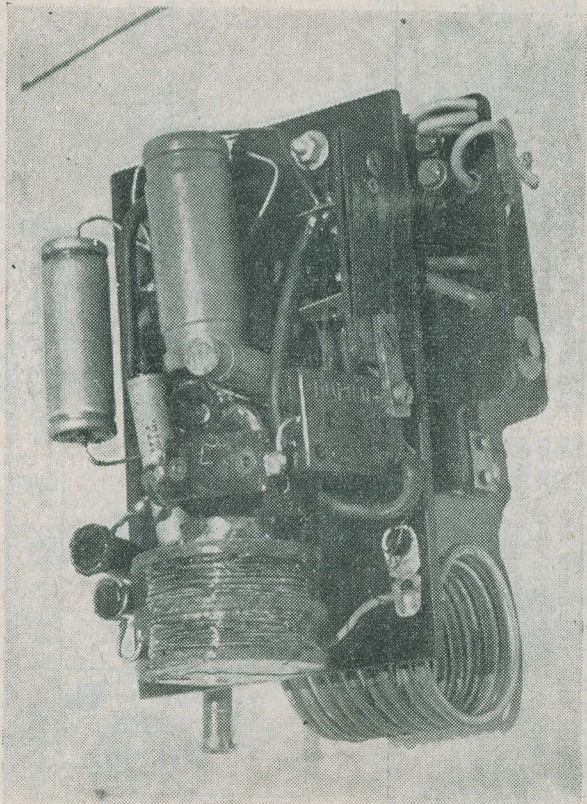

Underneath View showing Quench Coil and smaller components

The two RFCs shown consist of short lengths of $\frac{1}{4}$ " dowel rod, with sufficient 34 swg enamelled wire wound on so that the length of winding is 1". These can be fitted into holes drilled in the chassis and secured with Denfix cement.

Standard sized components are used, as previously mentioned, as no effort at miniaturisation was made. The filament and HT leads can well be taken to a small socket, so that filament and HT supplies can be plugged in as required. 1.4V LT is required, and 45V HT.

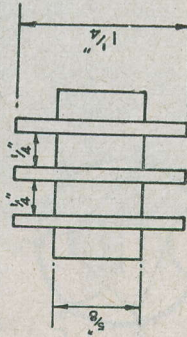

Coil Former details.

C587

Tuning Up

There should be little difficulty in getting the receiver to work. First check the voltages and make sure that the filaments are alight, etc. A short length—say 18" or so—of wire should be attached as shown to act as an aerial. Tune over the 27 Mc/s range on the station receiver until the characteristic hiss is located and tune it on to 27 Mc/s by adjusting the tuning capacitor. Connect a milliammeter in the plate circuit of the second valve and note the current, which should be somewhere about 10 to 15 mA. Switch on the R/C transmitter and adjust the receiver frequency to its frequency as has been described previously. On switching the transmitter carrier on and off, current change should be indicated on the milliammeter. Having got things working satisfactorily, connect in the relay and adjust.

The reader is warned that a certain amount of experimenting may be required to get the receiver oscillating just right. Adjustment of the length of aerial is important, as is the value of the resistor across the tuning circuit. If the hiss is too strong, the trans-

(Continued on page 308)

IN YOUR WORKSHOP

In which J. R. D. discusses Problems and Points of Interest connected with the Workshop side of our Hobby, based on Letters from Readers and his own Experiences.

Although Christmas festivities will be over and done with by the time that this appears, they are nevertheless still fresh in the mind of the writer, who has to plan his articles some months before publication. This year he produced for a party, amongst other things, a gadget designed to switch two sets of illuminations on and off alternately. As this device proved to be quite successful, and as it could be put to other uses, a description of it in these columns would not be inappropriate.

Fig. 1 (a) shows the circuit. This necessitates the use of a sensitive high-resistance relay paralleled by a high-value electrolytic capacitor. Both these components are fairly easy to obtain as surplus. The relay used by the writer was of the conventional P.O. type and had a 2,000Ω coil. The capacitor had a value of 500 μF at 24V wkg. The voltage of the battery and the value of the series resistor R were found by experiment, the writer getting best results with about 45 volts and a resistance of 6,000 ohms. Current drain from the battery, incidentally, was quite small.

The action of the device is very simple. On connecting the battery an energising current is passed via the resistor R and the de-energised contact A of the relay to the relay coil. At the instant of connection the voltage across this relay coil is zero. Owing to the presence of the large value capacitor, however, the coil voltage does not rise immediately to that needed to close the relay but, instead, rises slowly as the capacitor charges. When the voltage across the coil is sufficiently high the relay closes, whereupon its contact A disconnects the energising voltage. The capacitor now discharges through the relay coil. After a time, the voltage across the coil (provided by the discharging capacitor) falls sufficiently low to allow the relay armature to fall off. The contact A is then closed once more, completing the energising circuit through the resistor; and the cycle of events starts all over again.

It may be seen that the basic characteristic which allows the circuit to function lies in the fact that the voltage required to close

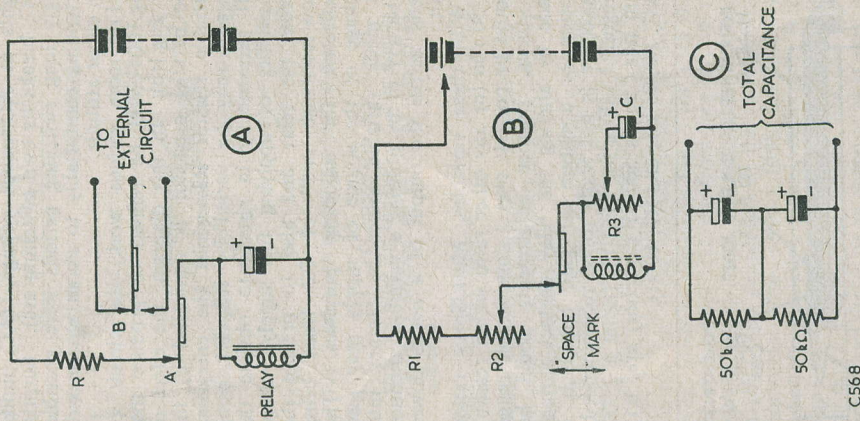

C568

Fig. 1 (a). A simple relay circuit for periodic switching.

Fig. 1 (b). A more versatile version of Fig. 1 (a).

Fig. 1 (c). How to connect two similar capacitors to obtain twice their working voltage. The capacitance is, of course, halved. (The values of resistance shown here apply for use with Figs. 1 (a) and (b)).

a relay of the type used here is higher than that at which it de-energises again. It is possible for the ratio between these two voltages to be as much as 2:1.

Once the relay circuit has been made to work satisfactorily, switching of external circuits may be effected by using spare contacts on the relay. The writer's relay had a pair of changeover contacts already fitted (contacts B in Fig.1(a)), and these were sufficiently large in themselves to switch small fairly lights at AC mains voltage. (AC, unlike DC, breaks its own switching arc). Surprisingly long switching periods were possible, extending comfortably to about ten seconds on either attitude.

For more serious work, the circuit of Fig.1(a) could be refined to produce that of Fig.1(b). In this diagram, the effect of the parallel capacitor is controlled by the variable resistor R3, whilst the energising current may be varied by R2; R1 being left permanently in circuit to obviate the possibility of applying full supply voltage across the relay and also to prevent the "low-resistance end" of R2 from being ineffective for adjusting purposes. The voltage of the source of supply may also be made variable, either by tapping into a battery or by utilising a variable potentiometer across the output of a mains power unit.

With these variables, Mark/Space ratios of 50:50 (or any other ratio within reason) should be possible over a considerable range of times. Further adjustments could be made by altering the relay contact spring-tension or armature air gap, but such a procedure is not really to be recommended. Suggested values for Fig.1(b), (using a 2,000 ohm relay and a 500 μ F capacitor) are: R1, 4 k Ω ; R2, 25 k Ω ; and R3, 10 k Ω .

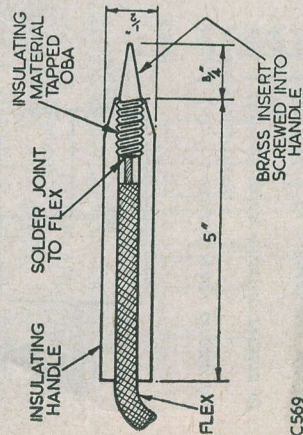

C-569

Fig. 2. Suggested design, with approximate dimensions, for an efficient and sturdy test prod.

As some of the high-value capacitors at present available have small working voltages, two or more of them may be put in series so long as voltage distributing resistors are connected across them. A typical example is shown in Fig.1(c). The two resistors keep the voltages across each capacitor equal.

Test Prods

A much maligned item seen on every test bench is the test prod. How many times does one see voltage checks being taken from radio equipment with the doubtful aid of a pair of kinked and frayed pieces of wire?

Most commercial test meters are supplied with good, really strong test prods whose useful life is at least that of the meter. Unfortunately, although they rarely get broken, these prods still get lost or mislaid. Home-made meters also require prods. Test prods can be bought, of course, but most people seem to prefer to make their own versions.

There appear to be two schools of thought about the test prod. Some people consider that as it is subjected to a great deal of harsh treatment, together with its lead, there is little point in making anything but a temporary prod whose life is deliberately accepted as being short. These people, therefore, make a simple arrangement consisting of, say, a piece of flex soldered to a five-inch length of heavy wire or brass rod, the whole being covered with insulating tape except for half-an-inch or so at the tip. The time taken in manufacture is approximately ten minutes or so. Of course, it is accepted that such a prod is hardly a thing of beauty. Nor is it intended to be a joy for ever, because, after several months or so of use, the flex is fairly certain to start breaking away at the solder joint and the tape to peel off. Nevertheless, another prod can easily be made by simply soldering on another piece of flex and fitting new tape. There is, after all, something to be said for the prod which is made to last only for a short space of time.

Those of the second school of thought like to make their prods to last. The writer tends to agree with them. It is very pleasant to have something solid and well-insulated in one's hand when one has a lot of testing to do. The type of flex to fit to the prod is also of importance. Single tinsel cords, as used for headphone flexes, are surprisingly long-lasting and are also very flexible, but they are only reliable for testing voltages—and then up to a limit of about 250 volts. Some of the plastic-insulated flexes appear

to be tougher than their rubber-and-fabric covered equivalents, but the plastic has the disadvantage of melting very quickly if it accidentally touches anything hot, such as a soldering iron. Perhaps the best solution consists of using, say, a strand of heavy rubber-and-fabric covered mains flex, accepting the fact that it may have to be replaced after a year or so of heavy use.

A suggested test prod is shown in Fig. 2. This should not prove to be at all awkward to make and it should last for many long years. It will be seen that it is quite simple to replace the flex. The material for the insulated handle may be slightly difficult to obtain, but a little ingenuity, plus a search in the junk-box, should suffice for most cases.

Headphones

Apart from potential test-prod handles, junk-boxes sometimes contain old headphones as well; these being perhaps a relic from the days of the communal family crystal set. Many of these are still capable of comparing very favourably with modern models. The remainder, however, will be found to have lost their former sensitivity, this being due mainly to the decline in power of the magnet. Nevertheless, these old headphones still have their uses. As they stand, each unit is capable of acting as a fairly useful (but somewhat resonant) AF choke for temporary or experimental purposes. More useful are the bobbins, however. If, after stripping the phones, these can be removed from their pole-pieces without damage, they make very good RF chokes of the "reaction" kind for ultra-midget receivers. The bobbins are simple to mount, the easiest method being to pass an 8-BA bolt through the oblong holes in their centres and holding them on the bolt with 8-BA nuts and washers.

Aerial Systems

It is pleasant to be able to have several aerials for one's workshop, but the question of switching these aerials, without losses, to various receiver and bench positions sometimes becomes a little involved.

A solution to this problem consists of making a distribution panel of the type shown in Fig. 3(a). This panel is capable of handling three aerials and four receiver or bench positions, but it could, of course, be extended. The aerials are connected to three vertically-mounted brass strips, these being mounted behind a plate of insulating material; whilst the output points are taken from four horizontal strips fitted to the front of the plate. The strips and plate are drilled at each point

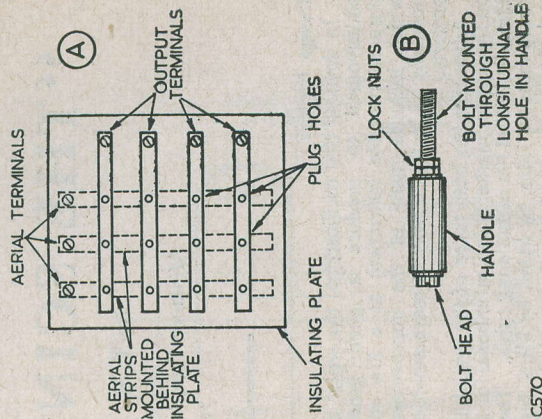

C-570

Fig. 3 (a). An aerial distribution board.

Fig. 3 (b). A suggested "screw-in" shoring plug for the board. The handle could preferably be made of insulating material.

where the strips intersect, thus allowing the passage of a plug connecting the two appropriate strips together.

To ensure a good connection, the holes in the rear strips are tapped. Those in the front strips and in the insulating plate are drilled to give a good clearance to the particular thread chosen for these tapped holes. A shoring plug, made as shown in Fig. 3 (b), may then be screwed through the front into any of the rear strip holes and will automatically ensure a good tight connection to the corresponding horizontal strip. Apart from the fact that, when the insulating plate is sufficiently thick, stray capacitances between aerials and output points are low, the system has the great advantage that it is as versatile as it possibly can be. Not only can any aerial be routed to any output terminal, but outputs, aerials, or both together, can be paralleled into any combination whatsoever. A larger number of aerial or output terminals may be obtained by incorporating more strips into the distribution board when it is originally being made. The number of shoring plugs required will be equal to the number of vertical or horizontal strips, depending upon which is the greater.

cathode line; but even without this, the linearity of the stage is excellent.

A switch throws into operation the attenuator on the input side of the valve, and with this in use voltages of 300 or so may be applied to the amplifier with safety.

CRT Unit

The arrangement of the resistance chain across the tube is straightforward, provision being made to modulate the grid from an external source, via the fourth position of the flyback suppression switch.

Should the Brightness control fail to cut down the trace to zero, due to the varying characteristics of different tubes, the value of this potentiometer should be increased from 30 k Ω to, say, 40 k Ω , or a 10 k Ω resistor inserted between it and the EHT negative line.

The final anode and shift controls are taken to a potential midway between chassis and HT positive, thus giving a further 150 volts on the tube above the normal EHT voltage.

Power Pack

A standard mains transformer is used, having two 4V windings. The HT winding may be anything from 250-0-250 to 350-0-350. One side of this output is connected to chassis, the centre tap ignored, and the other side taken to both HT and EHT rectifiers in opposite sense. The HT voltage should be between 300 and 400, and if a high voltage transformer is used, the value of the 2-watt resistor in series with the smoothing choke should be increased, or alternatively the HT feed to the rectifier could be taken from the centre tap on the transformer secondary.

The EHT voltage is not critical. In the unit shown, it is just under 500 volts, and produces a trace with plenty of brilliance in hand. It should be remembered that deflection sensitivity is increased by reducing this voltage, and this can be done if necessary by increasing the resistance between the two capacitors: try half a megohm for a start. Conversely, too

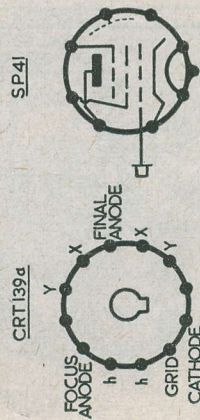

FIG. 2
TUBE CONNECTIONS SEEN FROM UNDERSIDE OF HOLDERS.

low an EHT voltage will produce bulb charge, when the screen will glow all over, the trace being absent.

The unearthed side of the 4V valve heater winding is taken to an external terminal, and can be linked to the deflection amplifier for synchronization of the time-base.

The second 4V winding supplies the CRT heater, and as the CRT cathode will be at full EHT below chassis, this winding should be left "in the air," thus lessening the chance of heater/cathode breakdown in the tube, or of arcing between windings in the transformer.

The HT rectifier must withstand the full voltage across the secondary winding, i.e., 500 volts in a 250-0-250 transformer. In the instrument shown, two 300 volt type rectifiers were used in series, capable of passing 20 mA.

A similar arrangement of rectifiers connected the reverse way round may be used for the EHT supply, or alternatively a pencil type rectifier of the 2 mA class may be used, as the current consumption is almost negligible.

Construction

In building an oscilloscope in so small a space the most important consideration is adequate screening, and though this may result in the wiring and placing of components becoming rather intricate, the resultant instrument is well worth the trouble and patience.

The mains transformer is placed underneath the chassis at the back, and is separated from the rest of the sub-chassis work by a screen across the full width of the box. The remainder of the power pack components are above chassis to the rear of the tube; the smoothing choke being placed directly behind the tube holder. In spite of these precautions stray fields affected the trace, and it was found essential to fix a mu-metal screen around the tube. As none was available for this type of tube, one was eventually made by cutting and bending half a shield made for the popular VCR97, as these are easily obtainable.

The tube resistance network is also placed above chassis, with the Brilliance and Focus potentiometers mounted on a piece of tufnol beneath the tube holder. Insulated extension spindles are taken from these controls through supporting brackets to the front of the instrument; slots to accommodate them being cut in the front of the cover beneath the hinged window.

The two valves and a few capacitors complete the components above chassis.

The remainder of the sub-chassis space is divided by a screen into two compartments, one for the amplifier and one for the time base. The accompanying photographs, Figs. 4 to 6, show where the various controls are placed.

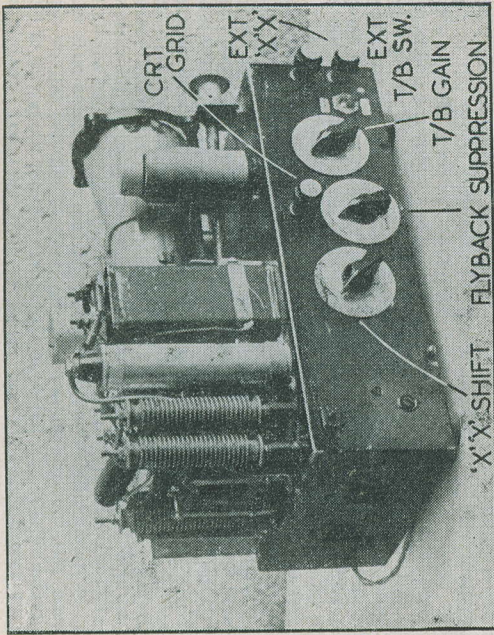

Fig. 4. Timebase side, identifying controls.

A word may be said about the flyback suppression switch. It was considered advisable to insulate this from the chassis, and it was therefore mounted on a piece of perspex with a tufnol extension spindle. This can be seen in Fig. 6.

As any interaction between time-base and amplifier would upset the trace, it is essential to screen the grid leads to both valves, and also advisable to use screened wire for the anode connections as well; particularly for the comparatively long leads from the outputs of both time-base and amplifier to the deflection plates.

The writer was fortunate in obtaining a set of ivoryine pointer scales suitably engraved, and these together with a handle and rubber feet greatly enhance the general appearance of the oscilloscope, and give it a pleasing and professional finish.

Safety in Use

For those readers not used to handling an oscilloscope, a word of warning may here be given. When connected to the external apparatus, the chassis and case of the instrument are often alive with respect to earth or the external apparatus, and the risk of shocks is considerable; e.g., when an AC/DC set is on test, both chassis may be at full mains potential above earth.

The Golden Rules for safety are:—

1. Unless the operator knows *exactly* what he is doing, all connections should be made with oscilloscope and external apparatus switched off.

2. When ready, switch on the oscilloscope first, and after observations, off last.

3. During observations, touch nothing but the insulated control knobs.

Regarding these control knobs, the usual precaution should be taken of ensuring that grub screws do not project. They should be well into the knobs with the cavities above filled with wax.

General Operational Notes

Having constructed the Scintilloscope, the first thing to determine is a rough idea of the settings of the frequency controls for different running speeds of the time base. For this purpose the 4V AC terminal is connected by external link to the deflection amplifier input, and the time base set so that one complete sine wave is visible on the screen. The time base is now running at 50 cycles per second (assuming no power cut!) and the settings should be noted. If the time base is adjusted so that several complete waves appear, say five, its speed will be 50 divided by the number of waves; in this case 10 c/s.

If the time base speed is increased above 50 c/s a point will be reached when half a sine wave appears with the second half superimposed upon it. At this setting the speed is 100 c/s. A speed of 200 c/s would show the wave cut into four pieces, all superimposed on one another.

To determine higher speeds, a variable audio frequency oscillator is required, and the following example is typical of the method

employed. The time base is set as above, to run at 100 c/s, the AC line being connected also to the external sync terminal. Leaving this sync connection, the AC line is removed from the deflection amplifier and the oscillator substituted. The oscillator frequency is then varied until four complete waves appear, and the time base speed increased until this changes to one wave. Evidently the time base is now running at 400 c/s. By increasing the oscillator frequency until four more waves appear, and the time base speed until this becomes one again, the time base can be set to 1,600 c/s, and so on.

It will be noticed that if the audio oscillator is not calibrated, this may be done as the above operation proceeds.

For making external connections, screened wires should be used, and it is a help to have a selection at hand. The most useful terminations are a spade tag at one end and a crocodile clip at the other, with tags on the screening braid for connections to chassis.

In order to prevent burning the fluorescent material on the screen, the Brilliance control should be turned right down when switching on, and turned up slowly after the apparatus has had time to warm up. This should never be done with the time base switched off and nothing connected to the other axis, as under these conditions a single spot of great brilliance would be produced, very liable to burn the screen. The Brilliance control should in fact never be turned up more than necessary, as to do so shortens the life of the tube and also decreases focusing.

When using the time base, after the trace has been made as steady as possible by the frequency controls, the sync gain should be turned up gradually until the image just locks and no further. The less sync in use, the less likely is the linearity of the time base to be affected.

It should be remembered when using the time base in studying a waveform, that its last fraction of length is missing; the time that would have been taken to describe it being occupied by the quick flyback line. For this reason, if it is required to study a waveform at its extreme end, the time base speed should be halved, thus producing two waveforms, and the first one examined.

Operational Functions

In addition to applications in Radio work, the number of fields in which oscillographs are now playing a vital part is rapidly becoming Legion. Techniques have been developed covering industrial use in measurements of pressure, strain, transients, etc., and in the hospitals electrocardiographs are now standard pieces of equipment. Two better

known uses are in Radar and Television. In this section, an attempt has been made to set out some of the basic uses of the instrument in Radio technique, and it is intended primarily for those with no previous experience in its use.

Many textbooks have been written on oscilloscope procedure, and it is impossible in a short article to cover more than a part of the subject; and that part only in broad lines. It is hoped that these notes will tempt the newcomer to seek more detailed information, and give him the desire to explore further into this fascinating field.

Applications of the oscilloscope to Radio can be placed briefly into three classes:—

1. Using one axis only.
2. Using both axes, the horizontal one being run by the built-in linear saw-tooth time base, with the unknown variable applied to the vertical axis, and therefore showing as a function of time.
3. Using both axes, the control variable being other than linear time.

Class 1

Under Class 1 comes the simple measurement of AC voltage (or current, if voltage drop is measured across a relatively small known resistance); the beauty of this method is that it is not affected by frequency, and imposes no load on the source.

A known AC voltage is applied directly to the external YY plates and the length of the vertical trace measured with a graduated perspex scale or piece of transparent graph paper stuck on the back of the hinged window. The unknown voltage is then substituted, and the ratio of the two voltages is equal to the ratio of the lengths of the two lines.

For small voltages the deflection amplifier should be used, where again voltages will be proportional for any one setting of the amplifier gain control.

It should be noted that the actual peak to peak AC voltage is measured, which is $2\sqrt{2}$ plus $1\sqrt{2}$ positive above neutral plus $1\sqrt{2}$ negative below.

With this single axis technique, the effectiveness of crossover networks and audio filters may be estimated. Equal voltages at different frequencies from an AF signal generator are passed through the network under test, and the output voltages also measured. A graph can then be plotted showing the voltage variation with frequency.

When using only one set of plates, it is advisable to connect the other set via capacitors to chassis, to prevent stray charges affecting the trace.

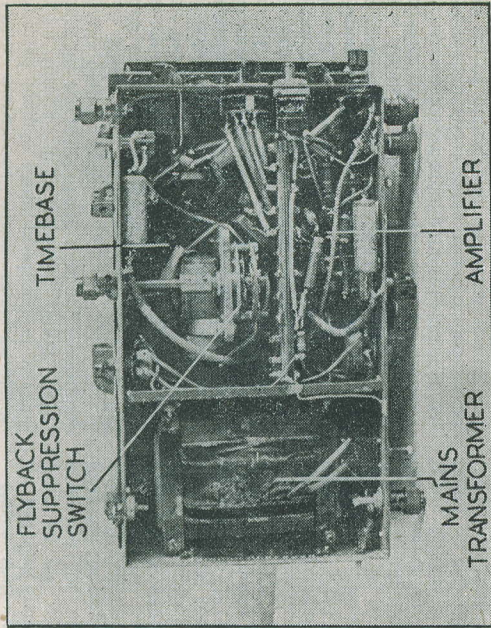

Fig. 6.
Sub-chassis view.

Class 2

In Class 2 we have the bulk of the work to be met with in Radio. The frequency calibration method described in the general operational notes is an example of this class, which gives graphical pictures of any waveform.

Another typical example of the use of the linear time base is in correcting the linearity of television time bases. If the output from one of these is connected to the vertical axis, and the oscilloscope time base adjusted until two or three cycles of the saw-tooth waveform are seen, any non-linearity in the television scan signal is at once apparent.

Hum in radio sets is speedily traced. Signals from various points in the set—valve anodes and grids working back from the output valve—are fed to the oscilloscope via the deflection amplifier, until the stage where their introduction takes place is isolated.

A point of interest here is that if full wave rectification is used, the ripple will have twice the mains frequency; therefore hum from this source may be distinguished immediately from mains pick-up.

The normal tracking and aligning of radio sets comes in this group, the oscilloscope being used as an output meter. Modulated RF is fed to the receiver from a signal generator, and the output from the diode load resistor taken to the vertical axis input through a 2 MegΩ resistor. This latter is to prevent

the deflection amplifier circuit from affecting the receiver.

The AVC line is disconnected, and the receiver aligned in the usual way, for maximum signals on the screen.

Another use for the linear time base is in measuring modulation percentages. The carrier, modulated by a constant frequency, is fed direct to the vertical plates, or via the deflection amplifier if necessary and provided the frequency is within the scope of the amplifier; and the time base is set to a multiple of the modulation frequency.

A solid figure will appear on the screen showing the modulation waveform symmetrical about the horizontal axis; the solid portion or envelope being filled in by the carrier.

The time base is locked to the modulation frequency and the maximum and minimum voltages measured as before. The maximum voltage "E" will be measured from the horizontal axis to a peak; the minimum "e" to a trough. Any units can be used as the ratio only is required.

Percentage modulation is then given by:—

$$\%M = \frac{E - e}{E + e} \times 100$$

It will be seen that for 100% modulation, the troughs will just reach the horizontal axis, i.e., e = 0, while if the carrier is over-modulated, the envelope will not be continuous, but will be split up into disjointed blobs.

Other waveforms which may be easily inspected include those produced at various points throughout a vibrator power pack, where the efficiency of vibrator and smoothing circuits may be seen.

In short, any periodic waveform can be made to reveal its shape, provided the frequency is within the limits of the oscilloscope time base.

Though not connected with Radio, it is interesting to note that the ignition system of a motor car may be examined by connecting the LT side to the vertical axis, the engine running at constant speed and being synchronized with the time base.

Class 3

Operations under this class are carried out without the use of the built-in time base, though with discretion the deflection amplifier may occasionally be used.

Phase angles are among the subjects covered. Suppose an AC voltage is connected across one set of plates, and the same source also to the other set. Each set of plates will tend to deflect the spot along its axis, and as both forces are in phase these tendencies will be equal in magnitude at any instant, though at right angles in direction. The resultant line along which the spot will actually travel is then clearly the diagonal of a square of forces constructed on the two axes, and therefore at 45° to both.

It should be mentioned that the sensitivities of the two sets of plates vary slightly due to their different positions along the neck of the tube, and in order to get equal deflections along each axis, the applied voltages must also vary slightly. This can be done by using a non-inductive potentiometer or resistance network.

If the two signals are 180° out of phase, the rate of increase of one will equal the rate of decrease of the other, and once again a straight line will be drawn; this time at 90° to the previous one.

For a phase difference between these two points, an ellipse will appear, beginning as a thin one at angles near 0° and 180°, and fattening out to a circle when the two signals are 90° or 270° out of phase.

If the axes of such an ellipse are measured, the phase angle θ may be found from:—

$$\text{Breadth} = \tan \frac{\theta}{2} \text{Length}$$

If the voltage across a load is fed to one set of plates and the current (*i.e.*, the voltage developed across a small resistance in series with the load) to the other plates, the Power Factor of the supply working into that load can be ascertained from:—

$$\text{PF} = \cosine \theta$$

Phase shift in amplifiers can be found for different frequencies by feeding the signal from an AF generator to both the vertical axis and the input of the amplifier under test; and the amplifier output to the horizontal axis. It may be necessary to feed the vertical axis via the deflection amplifier, in which case this amplifier should itself be carefully checked previously for phase shift.

Frequency comparisons up to a ratio of about 8 to 1 can be made by supplying a variable known frequency to one axis and the unknown to the other. By varying one frequency, points will occur when the moving jumble of lines on the screen suddenly lock into fixed geometrical patterns called Lissajou's Figures. At these points one frequency is a multiple of the other, and the ratio of the frequencies is the ratio of the number of loops along the top of the figure to the number down one side. As might be expected, the phase angle will alter the pattern, but the rule still applies.

Another operation which can be performed on the oscilloscope is that of determining and adjusting the frequency response of tuned circuits, *e.g.*, IF transformers and band-pass filters. A sweep-frequency generator or wobulator is required, which it is not proposed to describe in detail here, but briefly this instrument produces a signal in which the frequency varies over a small predetermined band, this sweep being repeated at, say, 50 times a second. The instrument also contains a time base, not always linear, locked to the same frequency of sweep. If this time base drives the horizontal axis of the oscilloscope, and the swept frequency is fed through the circuit under test to the vertical axis, a peaked curve results showing the frequency response. Sometimes the built-in time base is used, a portion of its output being fed into the sweep-frequency generator to control the period of sweep.

Graphical representation of valve characteristic curves also comes in Class 3.

A simple circuit can be set up taking its power via a transformer from the mains, where the mains voltage acts as a time base on the horizontal axis, and also varies the grid volts on the valve under test. If the vertical axis is controlled by the anode current, an Eg/1a curve will appear on the screen. Another comparable circuit can be used to draw Ea/1a curves.

So far no mention has been made of modulating the oscilloscope tube, as operations of this type are in a class by themselves.

Modulation signals applied to the grid terminal will affect the brightness of the trace but not its shape. For instance, if

[Continued on next page

TRADE NEWS

Miniature Maxi-"Q" Coils

This is an interesting new range of coils introduced by Denco (Clacton) Ltd., Old Road, Clacton-on-Sea, Essex. Designed for use with a 300 pF tuning capacitor, they are equally suitable for chassis mounting or for plugging into a standard Noval holder. The complete range covers 150 kc/s to 31.5 Mc/s approx.; two further types cover from 30 to 78 Mc/s approx. when tuned with 50 pF variables. Straight receivers with reaction and superhets with either 465 or 1600 kc/s IF's are covered. LF ranges are wound with Litz wire, and the iron-core (adjustable) formers are in colour-coded moulded polystyrene.

All two-winding coils are priced at 3s. 11d., and three-winding (grid, reaction and coupling) are available at 4s. 9d. Coil formers with cores are priced at 1s. 8d. for both the 4-pin types (blue, yellow, red and clear) and the 6-pin (green).

Complete technical information on the coils and recommended circuits are given in the Denco Technical Bulletin D.T.B.4., price 2s. 6d.

Scintilloscope, continued

A small external television frame time base is connected to the vertical axis, the oscilloscope may then be used for testing video receivers, the built-in time base being used for the line sweep. The video signal is fed to the grid terminal, the sync connections made, and the picture will appear on the screen (negative if the signal is negative-going and intended for cathode modulation). The tube can, of course, be modulated with signals other than television; if a sine wave signal is used, the trace will be alternately bright and dark.

A final word on a matter quite divorced from Radio:—if you have a camera and wish to test the shutter speeds, photograph a couple of sine waves using the 4V AC terminal. These two waves took 1/25th of a second to be traced, and from the length photographed, can be determined the time during which the shutter was open.

Away from the "Four plus One"

continued from p. 313

be chosen to produce the IF of 465 kcs when tuned by C2. Wearite "p" type coils are ideal for these positions. So are Osamor "Q."

The IF transformer should be a standard 465 kcs component with the reaction winding of fifty turns of 36 swg enamelled wire added

Deflecting Coils

Haynes Radio, Ltd., Queensway, Enfield, Middx., inform us that their deflecting unit Type S27, which conforms to the American requirements for wide angle scanning and is thus suitable for large diameter tubes, has been available since August 1951.

Cored Solder

As from February 25th, the Head Offices of Multicore Solders Ltd., have been removed to their new factory at Marylands Avenue, Hemel Hempstead, Herts. The offices at Mellier House, Albemarle Street, are being retained only as London West End Executive Offices.

The new factory is claimed to be the world's largest specially built for the manufacture of cored solder.

Owing to the rapid expansion of home and export sales of Ersin Multicore Solder the location of Multicore production has moved three times in twelve years, and the new works is eleven times the size of the original works at Walthamstow. Many novel features, both in building technique and plant, are incorporated in the new premises.

to the secondary.

Note on the UCH21

This is an all-glass B8G—base valve, with the cathode connected to the metal spigot.

In their valve reference manual, Messrs. Mullard show both the positive-cathode-bias and negative-grid-bias systems, in the valve's various uses.

Cathode-bias is shown in Fig. 1, but if there is any likelihood of the spigot shorting to the chassis (since it is connected to the valve-base ring) omit the resistor, connect the spigot to chassis, and bias the valve via the resistor Rb as shown in Fig. 2.

A FORTNIGHT IN COPENHAGEN

Mr. Harold Andrews, G5DV, is organising another of his overseas visits this year, this time to Copenhagen. Those who have been on these trips or read about them, will know that nothing more could be desired in the way of a well organised, friendly holiday. This year the party will leave Harwich by the Night Boat on 17th August, leaving Copenhagen by the Night Boat on 1st September. The return fare including berths on the boat, reserved seats on all trains, is £17. Hotel rooms are being reserved, the cost of which will be between 7/6 and 10/-. Those interested should contact Mr. Andrews at his home QTH, viz., 175 Moorland Road, Weston-super-Mare, Somerset.

QUERY CORNER

A "Radio Constructor" Service for Readers

A Tuning Unit

We frequently receive requests from those who have constructed high fidelity amplifiers for circuit diagrams of tuning units. It might at first be imagined that a tuning unit is simply the RF portion of any suitable radio receiver. This is not, however, the case because the quality enthusiast, having constructed a carefully designed high fidelity amplifier, expects to receive the radio programmes with the same sparkling clarity that he obtains from the record player; and in general this is not available even at the detector stage of the normal receiver. A quality tuning unit is, accordingly, a unit which has been specifically designed to receive signals from the local stations with the highest possible fidelity and freedom from interference. Such units are not required for long distance working, because weak signals invariably suffer fading distortion and various forms of interference; these are effects which cannot help but mar fidelity reception, no matter how carefully the circuit is designed. Thus, as has already been pointed out, the construction of a tuning unit

presents problems which confront a considerable number of our readers, and so perhaps we might ask the forgiveness of those whose interests lie in other aspects of our hobby if, this month, we allocate this space to the description of a rather interesting tuning unit.

When planning a tuning unit for use with a high quality amplifier, the first point which has to be decided is whether or not to employ a superhet or a straight circuit. The superhet offers the advantage of better selectivity and it is in many ways easier to construct, but in this instance we are not primarily concerned with selectivity or even sensitivity, but mainly with the response of the RF stages. In other words, we are interested in ensuring that the pass bandwidth of the RF side of the receiver is at least ± 12 kc/s and may with advantage approach ± 15 kc/s. It is important, however, that in obtaining this bandwidth the selectivity of the unit is not degraded to the point where it is impossible to separate the local stations. The use of a straight two-stage receiver employing a bandpass tuned circuit provides a response which satisfies these requirements.

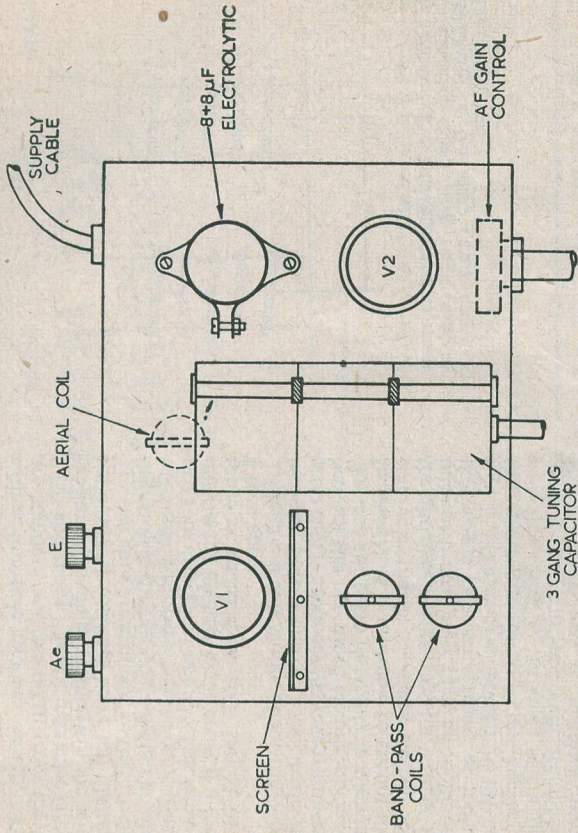

FIG. 2 THE LAYOUT USED IN THE ORIGINAL UNIT COMPONENTS SHOWN DOTTED ARE BELOW THE CHASSIS

C577

In this design, the sensitivity is adequate for the reception of the three BBC programmes in most parts of the country, but if the signal level of any one station is unduly high a rejector circuit may be necessary to provide adequate separation.

The circuit diagram of the complete unit is shown in Fig. 1, and it will be seen that no power pack is included, it being assumed that the HT and LT is to be taken from the main amplifier supply. The circuit consists of a high gain RF amplifier bandpass coupled to an infinite impedance detector. The use of three tuned circuits enables a very satisfactory degree of selectivity to be obtained, whilst a critical choice of coupling between the coils in the interval circuit provides the required bandwidth. The infinite impedance detector presents negligible damping on the final tuned circuit. To give the most linear detection characteristic, the signal level at the input to this stage must be 5 volts or more. This means that the signal voltage at the cathode of the valve will be a little over 4 volts, and as the unit is intended to feed into the input of an amplifier, an attenuator having a 10:1 reduction ratio is provided to give an output voltage in the region of 0.4 volts. This is suitable for supplying to the tone compensating

circuit of the Williamson and many similar amplifiers.

It is possible to overload the first valve on strong local stations, and to prevent this a bias adjustment is provided. This control is intended solely as a means of preventing the first valve overloading, and for reasons already stated concerning the correct operation of the detector it must not be employed as a volume control. An AF volume control is included in the output circuit, but this may be substituted by a fixed resistor when a gain control is fitted at the input to the amplifier.

For convenience, both valves are shown as EF50s, but almost any triode or triode-connected pentode having a medium μ may be used in the detector stage. The tuning unit requires a power input of 6.3 volts at 0.6 amps, and has an HT current drain of about 12 mA. The HT voltage within the unit should be around 225V, and as the main HT line in the amplifier will in all probability be higher than this a dropping resistor will be required. This resistor in conjunction with an 8 μ F electrolytic capacitor also forms a smoothing and decoupling filter between the tuner and the amplifier. The dropping resistor value quoted on the circuit diagram assumes a supply HT of 350 volts and its value must be adjusted if it is

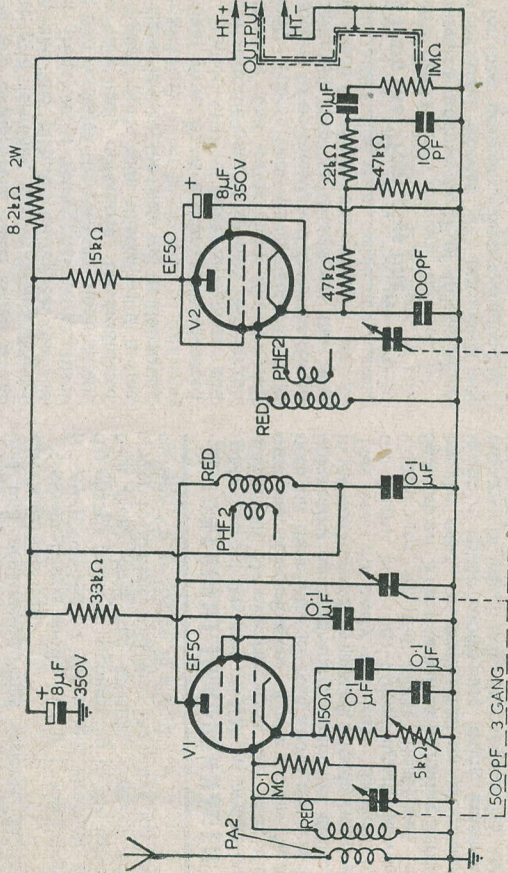

FIG. 1 CIRCUIT DIAGRAM OF THE TWO STAGE TUNING UNIT

C576

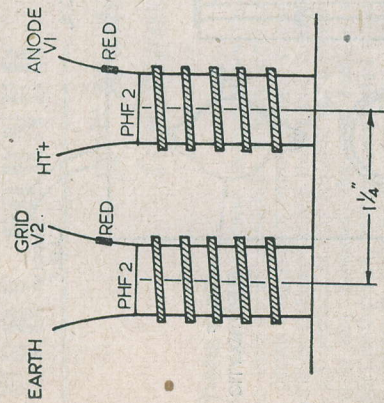

FIG. 3

SHOWING THE SPACING BETWEEN THE INTERVALLE COILS. THE TWO PRIMARY WINDINGS OF THE PHF2 COILS ARE LEFT UNCONNECTED

C 578

necessary to accommodate some other voltage. Turning now to the coil arrangement, it will be seen that in the circuit diagram provision is only made for tuning over the medium wave-band. In general, for units of this type single band coverage is adequate and obviates the need for relatively complicated switching circuits. However, should it be desired to add an additional range this may be achieved by using a further set of three coils in conjunction

with a four-pole two-way switch. The coils are standard and are taken from the Wearite "P" coil range. In the intervalle circuit only the tuned windings of the coils are employed, the coupling windings being left disconnected. The two coils are arranged so that the optimum degree of inductive coupling is obtained; this was found to occur when the centre lines of the two coils are $1\frac{1}{4}$ inch apart. This figure applies only to the medium wave coils; if a long wave range is added these coils should be spaced $\frac{3}{4}$ inch apart.

Finally, a few words about the component layout. This is one of those circuits in which great care is necessary to prevent stray coupling between the two tuned circuits; such coupling can lead to severe instability in the first stage. In general, it is advisable to mount the aerial coil under the chassis, using the rear section of the three-gang capacitor for tuning it. The intervalle coils may then be mounted above the chassis between screens, as indicated in Fig. 2. The spacing between the two coils and their relative positions to one another can be seen from Fig. 3. In cases where the main gang is not equipped with trimmers, small 50 pF presets may be mounted above each coil. The unit is best aligned on a weak signal if no signal generator is available. The procedure is simply to adjust each trimmer in turn for maximum response, and then to adjust the dial pointer to read the correct wavelength on the scale.

The tuning unit is connected to the main amplifier by means of a multi-way cable terminating in an octal plug. One lead in the cable is screened to carry the AF signal.

If due care is paid to the design points which have been mentioned, there can be no doubt that this tuning unit will provide most satisfactory results.

Radio Control of Models

continued from p. 294

mitter may not depress it sufficiently to give much current change in the plate circuit of the second valve. A little time spent experimenting with this circuit will prove most instructive, and will help one to get the 'hang' of this type of circuit quite soon.

In the next instalment in this series, we shall describe a miniature transmitter for use with this circuit.

AWAY FROM THE "FOUR PLUS ONE"

by F. L. BAYLISS, A.M.I.E.T.

PART ONE

Standstill

It is many years now—probably nearly twenty—since commercial radio design, having satisfied itself that the acme of perfection—the perfect receiver, in fact—had been evolved in the now familiar four-plus-one superheterodyne, brought itself to a standstill, and has continued thus ever since.

For twenty or more years, easily the bulk of the industry's polished and ornate output has been the familiar combination, FC—IF—DDT—OUTPUT PEN, with an occasional radio-frequency amplifier, preceding the frequency-changer in the "better-class receiver," and now and then—but, oh, so rarely—a real push-pull output stage.

Valve design, too, has tended to be evolved for and around this circuit, and combination valves such as the triode-hexode and duode, designed expressly for sections of the circuit, have been the order of the day.

But, although commercial design is proving so obdurately conservative in its choice of circuit and valve-order and, indeed, still shows no sign of changing to any other, there is no reason why the nimble and open-minded constructor should follow blindly in the wake of the commercial hide-bound pundits.

Neither does any deviation from the "eternal four-plus-one" necessarily mean a change for the worse; indeed, the writer is going to claim boldly that the designs presented in this short series, although employing fewer or the same number of valves, are considerably more economical to build and to run than the commercial product, and—dare he say it?—will give noticeably superior reproduction.

The Circuit

Is it possible to compress a full-bodied four-valve superhet into TWO valves—yes, just TWO valves?

Consider closely the circuit of Fig. 1 and you will see that this is precisely what has been done. The circuit has been evolved by the writer after a study of the possibilities of "combination" valves and, so far as he is aware, has never been built or published before.

V1 is a triode-heptode—the Mullard UCH21—whilst V2 is the Mullard UBL21 duode-diode-output-pentode. These two valves have been chosen because of (a) the convenience of the heater current rating, and (b) the suitability of the valve electrode arrangement.

Since the triode grid of the UCH21 is not connected internally into the heptode section, the two sections may be treated as separate and individual valves, and this is what has been done.

The heptode section alone functions as the frequency changer, with the signal input taken to g1, and the oscillator functioning between g2g4 (the screen grid) and g3.

The primary of the only IF transformer used is in the anode circuit of the heptode, and the secondary is taken to one of the diodes of the output valve.

The demodulated signal is then fed back to the grid of the triode section of the UCH21, which acts as an audio amplifier before feeding the signal finally to the grid of the output pentode.

Since there is no interaction between the two sections of V1, reaction may be safely taken from the triode anode and applied, via C6, to a small supplementary winding of about fifty turns on the IFT secondary. To this end, there is no RF by-pass capacitor at the diode anode, this filtering being carried out at the grid of the output valve.

The second diode of the latter valve supplies the AGC voltage to V1 by virtue of the small

QUERY CORNER

"Rules"

- (1) A nominal fee of 2/6 will be made for each query.
- (2) Queries on any subject relating to technical radio or electrical matters will be accepted, though it will not be possible to provide complete circuit diagrams for the more complex receivers, transmitters and the like.
- (3) Complete circuits of equipment may be submitted to us before construction is commenced. This will ensure that component values are correct and that the circuit is theoretically sound.
- (4) All queries will receive critical scrutiny and replies will be as comprehensive as possible.
- (5) Correspondence to be addressed to "Query Corner," Radio Constructor, 57 Maiden Vale, Paddington, London, W.9.
- (6) A selection of those queries with a more general interest will be reproduced in these pages each month.

ELPREQ PAGES

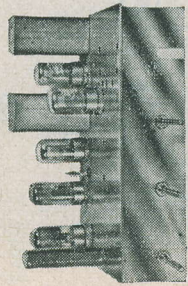

5 VALVE IF/AF AMPLIFIER

Chassis size 11 1/2" x 7" x 3" deep. Holes are drilled so that tuning condenser and coil pack may be fitted if same are required. Complete with 8" speaker and one of the latest valve line-ups as follows: 14S7 Triode Hexode, 7B7 IF Amplifier, 7C6 D.D.T., 35A5 output, 35Z3 Rectifier. The IFs are preset at 465 Kc/s AC/DC mains operated £6.10.0. A.C. only model available if required.

FULL VISION DRIVE

Parcel consists of scale pan with pulley, lens, glass scale, size 6" x 8" calibrated in metres and with station names printed, 4 scale fixing clips. Also included is drive drum, nylon cord and pointer. All makes up as illustrated either vertically or horizontally. Price 12/6d.

THIS MONTH'S SNIP SPECIAL 3-SPEED 'GRAM

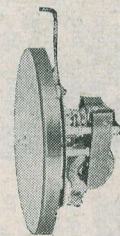

With records that play for almost 30 minutes there is really no need for an automatic changer, therefore we anticipate a heavy demand for this low priced but nevertheless very reliable motor. We are able to sell at this price because we bought a cancelled shipment, obviously a limited quantity is available so we advise prompt action. RECORDS at present sold in this country and also the new American types which will soon be available. **TURNTABLE:** 9in. heavy pressed steel with rubber mat (essential for long playing records). **MOTOR:** Extra silent running induction type, suitable for A.C. mains only. **DRIVE:** the modern rim method is employed, this is especially trouble free as no belts or governors are needed and speed is automatically controlled by the mains. **FIXING:** a fixing and drilling template is supplied. Clearances measured from the top of the motor board—depth 3in. and height 1 1/2in. **GUARANTEE:** £3/19/6, plus 2/6, carriage and packing. H.P. Terms £1/7/0 deposit and 6 monthly payments of 10/-.

14 DAYS' APPROVAL

Study our data for 14 days and if you think you can't assemble the Radio, Television or Radiogram then return it for full refund. Nothing to make simply assemble standard components and you will have professional instrument a half cost. Send for data (blueprints etc.) today. Radio 1/6, TV 1/5/-, Radiogram 2/6. Cabinets available separately.

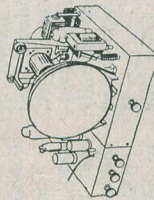

Parcel design, bakelite cabinet in ivory blue or brown complete with metal chassis punched out for speaker and 5 valves etc. Parcel also includes moulded perspex windows, matched set, knobs, scale and hardboard back. Price 27/6 carr. and pkg. 2/6.

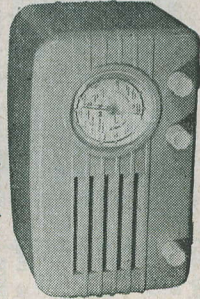

CONSTRUCTORS' PARCEL, SPECIAL OFFER

Modern design, bakelite cabinet in ivory blue or brown complete with metal chassis punched out for speaker and 5 valves etc. Parcel also includes moulded perspex windows, matched set, knobs, scale and hardboard back. Price 27/6 carr. and pkg. 2/6.

ELPREQ "WOLSEY" RECEIVER

This is a semi-portable long, medium and short wave super heterodyne receiver for A.C./D.C. mains by one of our famous manufacturers, fully aligned, tested and guaranteed, complete in cabinet.

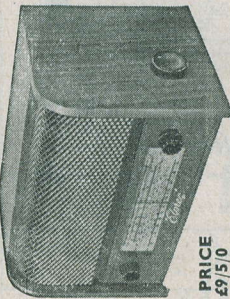

COVERAGE: long wave 800-2200 metres, medium wave 200-500 metres, short wave 13-50 metres. **CHASSIS:** heavy gauge polished aluminium, size 7 1/2in. x 5 1/2in. **DIAL:** size 7in. x 1 1/2in., illuminated, calibrated in metres and with printed station names. **SPEAKER:** 6in. in, permanent magnetic type, finest make. **TUNING:** long scale large drum and slow motion drive give perfect control. **A.V.C.:** with provision for external aerial if greater volume is required. **A.V.C.:** delay A.V.C. to list and 2nd valves gives good quality with minimum of background noise. **CONTROLS:** 3 only—tuning, volume, on/off switch, and wave change. **CABINET:** 12in. x 7in. x 7 1/2in. high, made from selected hard wood satin finish. **CIRCUIT DIAGRAM:** is available free with receiver or separately with each receiver. **GUARANTEE:** 12 months, written guarantee included with each receiver. **PRICE:** complete in cabinets ready to work, £9/5/0, carriage and insurance 5/-, H.P. terms £3/2/6 deposit and 10 monthly payments of 14/- each, carriage extra as above.

MAINS/BATTERY PORTABLE

Ultra modern cabinet, highly suitable for making up an all-mains and/or all-dry battery receiver. Cabinet dimensions, 7 1/2in. deep and 10 1/2in. high x 12 in. wide, imitation crocodile cabinet with back and wooden platform; battery dividers, inner front drilled for three controls, and handle, 22/6 complete. **Ivory Fret with Perspex Window,** loud speaker louvres and tuning scale, 5/6. **Frame Aerial** wired for long and medium wave with plug board and tag strip, 5/6. **Unwired, 2/6.** **Metal Chassis** punched out and with loudspeaker cut out, 5/6. **Assembly for holding dial and lamps, 1/9.** **Matched Knobs, set of 3, 2/-.**

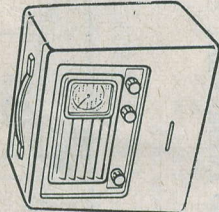

Or all items unwired frame aerial, 38/6; wired frame aerial, 42/6. Circuit diagram of suitable receiver free with cabinet

BATTERY PERSONAL CHASSIS

This 4-valve all-dry battery-operated receiver is of such small dimensions that it will fit into a cabinet still about 6in. x 4in. x 3in. and still leave ample room for batteries. The chassis is all wired and complete with speaker, volume control, wave-change switch, etc., etc., and only first-grade components have been used. Prices are: Chassis complete less valves (three type 1T4 and one type 3V4)—to operate on long and medium wave-bands, 59/6. Ditto but medium wave only, 49/6. Add 2/6 to cover postage and insurance.

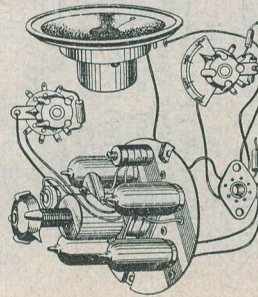

Orders under £2 add 2/6, under £1 add 1/9. Postable items can be sent C.O.D., additional charge approx. 2/6. List 6d. Early closing, Wednesday—Ruislip, Saturday—City.



PRECISION EQUIPMENT

Orders by post are dealt with by our RUISLIP depot. To avoid delay address to—E.P.E. Ltd., Dept. 3, Windmill Hill, Ruislip, Middlesex.

WINDMILL HILL, RUISLIP MANOR, 152-153, FLEET STREET, LONDON, E.C.4.

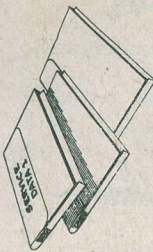

RADIO DATA

100 service sheets, covering British receivers which have been sold in big quantities and which every service engineer is ultimately bound to meet. The following makes are included: Aerodyne, Alba, Bush, Cossor, Ekco, Ever-Reason, Ferranti, G.E.C., H.M.V., Kolster, Murphy, Lissen, McMichael, Marconi, Mullard, Philips, Philips, Pye, Ultra. Undoubtedly a mine of information invaluable to all who earn their living from radio servicing. Our folder No. 2 consists of 100 data sheets covering most of the popular American T.R.F. and super-set receivers "all dry", etc., which have been imported into this country. Names include Sparton, Emmerson, Admiral, Crossley, R.C.A., Victor, etc. Each sheet gives circuit diagrams and component values, alignment procedure, etc., etc. Price for the folder of 100 sheets is £1 post free.



FLUORESCENT LIGHTING CONTROL UNIT

This is a combined condenser and choke unit for controlling 40 watt fluorescent tubes. The only other item needed is a starter switch which can be an automatic type or an ordinary on/off manually operated type. We offer these well-made units at less than half-price, namely 19/6 each.

T.V. TRANSFORMERS

TYPE 1—Fixed Primary H.T. Secondary 4 v. at 5 to 6 amp., 4 v. at 5 to 6 amp., 5 v. at 2.5 amp., 2 v. at 1 amp. Dimensions are 4 1/2in. x 4 1/2in. x 4 1/2in. Price 27/6, plus 2/6 p.k.g. and postage.

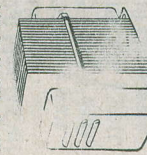

TYPE 2—Primary as Type 1, H.T. Secondary 300-0-300 v. at 150 mA. L.T. 7.5-0-7.5 v. at 3 amps., and 4 v. at 3 to 4 amps. Dimensions are 4 1/2in. high x 4in. x 3 1/2in. Price 17/6, plus 2/- postage and packing.

Orders by post are dealt with by our RUISLIP depot. To avoid delay address to—E.P.E. Ltd., Dept. 3, Windmill Hill, Ruislip, Middlesex.

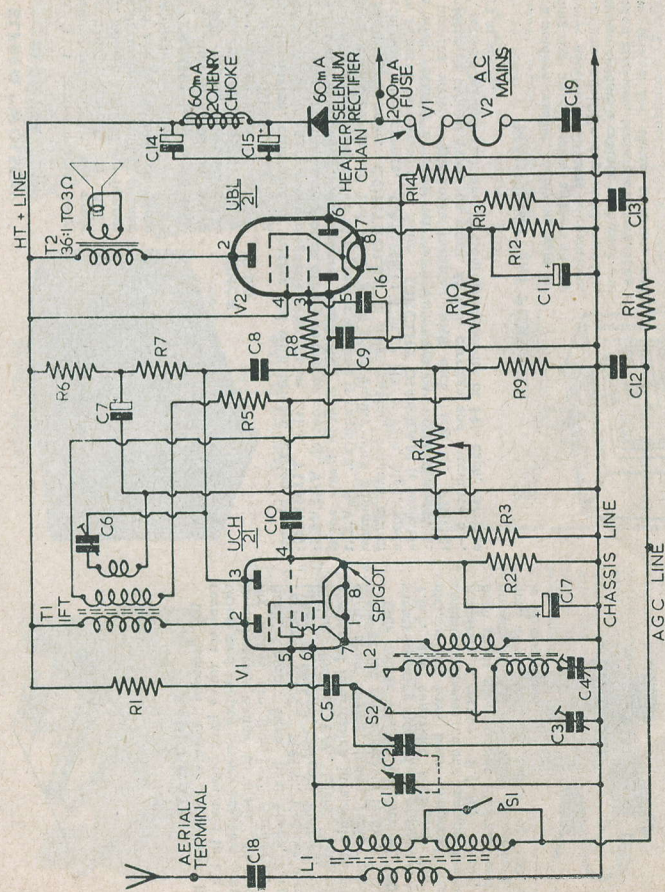

FIG. 1

C573

COMPONENTS FOR THE CIRCUIT OF FIG. 1

- R1 —33 kΩ, ½ watt.
- R2 —1.5 kΩ, ½ watt.
- R3, R9, R11, R14—500 kΩ, ½ watt.
- R4 —2.0 Meg Ω Carbon Potentiometer.
- R5 —20 kΩ, ½ watt.
- R6 —5.6 kΩ, ½ watt.
- R7, R10 —100 kΩ, ½ watt.
- R8 —10 kΩ, ½ watt.
- R12 —200Ω, 1 watt.
- R13 —500 pF Two-gang Tuning Capacitor.
- C1, C2 —600 pF Preset.
- C3 —300 pF Preset.
- C4, C6 —0.001 μF Mica.
- C5 —8.0 μF Electrolytic, 450 volts W.
- C7 —0.1 μF Tub. Paper.
- C8, C10 —100 pF Mica.
- C9, C16 —1.5 μF Paper Capacitor 1,000 volts DC working.
- C11, C17 —25 μF, 25 volt, Electrolytic.
- C12, C13 —0.02 μF Tubular Paper.
- C14, C15 —16 + 16 μF Electrolytic 450 V.W.
- C18 —0.002 μF Mica.
- V1 —Mullard UCH21.
- V2 —Mullard UBL21.
- S1, S2 —2P, 2W (or suitable) Yaxley Switch.
- L1 —MW and LW Aerial Coil.
- L2 —MW and LW Osc. Coil.
- IFT —465 kc IF Transformer.
- T2 —Output Transformer.
- 60—80 mA. 20 Henry Choke.
- 60—80 mA. Selenium Rectifier.
- 200 mA. Fuse and Holder.
- 3Ω m/c Loudspeaker.
- C19 —1.5 μF Paper Capacitor 1,000 volts DC working.

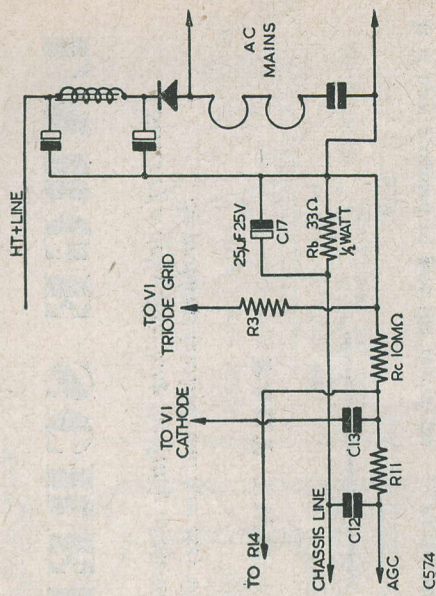

Fig. 2. Method of biasing V1 by resistors Rb and Rc.

C574

coupling capacitor C9; volume control (manual) is effected by variable negative feedback from V2 control grid to V1 triode grid, and thus the reproduction level, upset by the reaction, is in part restored.

Note that the high value of bias on V1—1.5 kΩ giving about -3 volts bias—is necessary for the correct functioning of the triode section, but will have very little effect upon the efficiency of the heptode section.

Note, too, that the valve heaters are series connected, and are provided with their 0.1A current via the capacitor C19. The value of C19, 1.5 μF for 230 volt AC mains, may be made up by 1.0 μF and 0.5 μF capacitors in parallel, but in all cases C19 should be suitable for 1,000 volts DC working and *not* electrolytic.

Constructors having access only to DC mains, or wishing to make an AC/DC version of the receiver, may replace C19 by a 1.5 kΩ, 20 watt resistor, or by five yards of 0.15A or 0.2A three-way line-cord. The line-cord has a resistance of about 100Ω per foot in the 0.2A range and the length given is correct for 230 volt mains.

Performance

Despite the extreme simplicity and economy of the circuit, the arrangement is substantially that of a standard four-valve—apart from the omission of an IF amplifier.

The reaction, however, can be adjusted to fill this breach, and indeed, is meant to do so, so that the two valves give a performance practically little short of a standard

“four-plus-one” with only about half the number of components!

In view of the few components needed, and of the absence of the bulky power pack transformer, the circuit lends itself ideally to construction as a midget receiver—perhaps built into one of the small white plastic cabinets now so plentiful and inexpensive—for use in, say, the kitchenette, the workshop or garage, or at the bedside, where it may occupy very little more space than a book.

The power consumed is startlingly low; with C19 in circuit one gets more than forty hours reception per unit of “juice”—i.e. at ½ d. per unit, more than fifty hours for a penny.

The AC/DC version dissipates about forty watts, giving thirty-three hours for a penny at the same rate.

Protection

Since the receiver is not isolated from the mains, C18 (common negative) and the aerial chassis (common positive) and the aerial terminal. This should be a good quality mica component having a value large enough to avoid unwanted resonance with the aperture winding of L1.

The value of 0.002 μF chosen, will be found suitable for most aerial coils.

The 200 mA fuse will protect the valve heaters in the event of C19 breaking down, and also the rectifier should either C14 or C15 fail.

The Coils

L1 may be any type of aerial coil of suitable wave-range, and the oscillator coil L2 should

Continued on p. 305

LARGE SCREEN T.V.

A Series of articles describing the fitting of the English Electric 16" tube, the problems involved, and how they were overcome.

PART TWO

It is now proposed to give the reader the procedure for the construction of the mask and focus-coil support, and to give this in a logical sequence. This latter is convenient, for it enables any discrepancy or variation in dimensions to be easily rectified as assembly progresses.

Baseboard

Prepare the baseboard and draw the centre dotted line as shown in Fig. 1 (last issue).

Set up insulators with clips for front pair and strong supporting wire for the rear ones. Earth fixing bolts on bases (a simple method is a brass or copper plate underneath the baseboard, bringing back a connection to the 7-pin plug on focus-coil board).

With insulators in position, place tube in front clips and mould rear supporting wire so that the tube is horizontal and the screen vertical. NOTE: Always handle the tube by the cone and screen—NEVER BY THE NECK. It is strongly urged at this point that GOGGLES BE WORN. The 16" tube bears a tremendous weight of air pressure against a hard-drawn internal vacuum. This may be calculated approximately from the formula $\pi R^2 \times 14.7$ lbs. per sq. in., = $3.14 \times 82 \times 14.7$ = by crude calculation some 3,000 lbs. bearing on the tube screen. Fortunately, the tube concerned here has a steel cone, and in implosion testis carried out by the English Electric Co., it was found that the glass screen collapsed into the cone with little attendant risk. Nevertheless, there is always that odd occurrence, and to afford protection there is no doubt that goggles should be worn, and indeed at all times when handling cathode ray tubes.

Make rubber band, slip over tube, and attach each end to rear of clips as shown in photograph, last issue. Tension the rubber so that the tube is held firmly in position.

At this stage of assembly, the tube becomes its own datum line and supplies practically all other points from which to work.

Front Mask Board and Rear Focus Coil Support

Prepare external measurements of front and rear boards, and cut to shape. These should be made of paxolin, plastic or three ply. DO NOT cut out mask opening at this stage.

Mark out from top to bottom a centre line on the inside of the front board, as shown by the dotted line in Fig. 3. With a tape measure, find the exact centre of the tube screen, and mark with a pin-head of paint. Now, by carefully placing the front board dotted line on the centre line marked on the baseboard, the paint spot may be transferred to the front board. Remove any remaining paint from the tube screen, while still wet, with soft cloth.

The mark on the mask board makes it exceedingly simple to draw the outline of the mask cut-out, dimensioned as shown in Fig. 3. Remember, when cutting out, to leave in the rounded corners of $1\frac{1}{4}$ " radius.

Obtain sufficient wood fillets, shaped to cross section as shown in Fig. 4, and glue and screw these all round the mask opening. Rough mitres are satisfactory, and the radiused corners may be ignored. NOTE: the angle on these wood fillets is important, as it determines the actual size of picture ($13\frac{1}{2}" \times 10"$).

Screw along the bottom inside of the mask board the wooden batten support, Figs. 3 and 6. Two screws are sufficient. The batten ends must line up with the focus board.

Hold mask board flush with front edge of baseboard, and screw the batten down. Remove mask board and make the batten a fixture on the baseboard. Wood fillets to carry final cover may now be screwed all around the edge—Fig. 3.

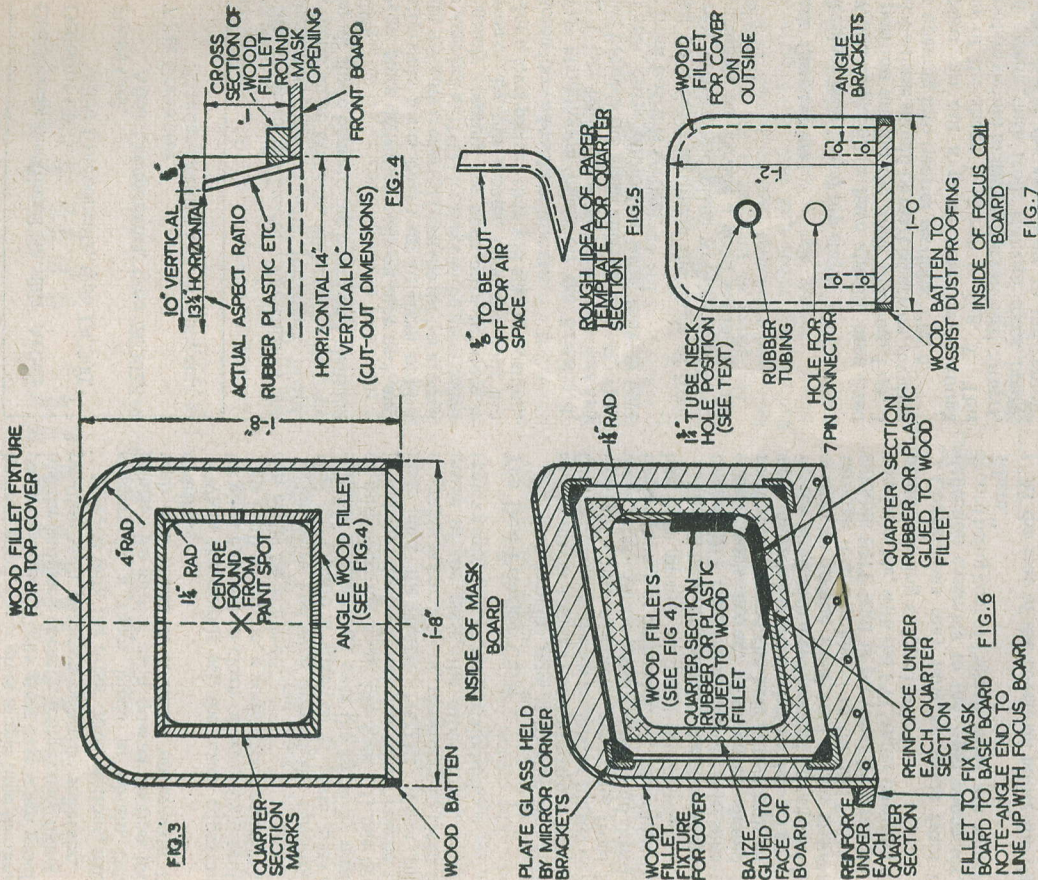

C575

Turn now to the rear focus support, and to the dimensions shown in Fig. 7. The position of the $1\frac{1}{4}$ " hole for the tube neck is not given, as once again this will easily be found by carefully sliding the board up to the tube base, and marking off.

The focus coil mounting holes may then be drilled out, using the actual component as a template.

Obtain about 6" of $\frac{1}{4}$ " rubber tubing, slit open, and fit around the tube hole, leaving it $\frac{1}{4}$ " short. When the tube is inserted into position, the rubber tubing may be made to fit snugly around the neck by taking up this $\frac{1}{4}$ " allowance.

Cut hole for 7-pin connector. Fit and fix fillets and wooden blanking-off batten—Fig. 7. The fillets are on the outside, and the batten

HARMONIC DRIVE

Part Six

By P. TURNER

be very good, for it gives ample time to mould parts to shape. Take great care when moulding the radiused corners, temporarily fixing in position with gummed paper or sellotape.

Proceed with the other three sections, using scissors or a razor blade to obtain clean joints. Re-inforce each quarter section joint with odd pieces of material underneath the overlap.

When thoroughly set, the inside edges may be glass-papered to clean off any slight faults. This is all so simple, a commercial appearance can easily be achieved.

Cut baize and glue around the opening—Fig. 6. Obtain a sheet of $\frac{1}{4}$ " plate glass of suitable size, and fix over the baize by means of mirror corner angle brackets. It has been found that dust will not penetrate between the glass and the baize. NOTE: When final assembly is carried out, remember to clean the inside of the glass, the tube screen, and to remove any dust in the installation.

Top Dust-Proofing Cover

All that remains now is to glue two sheets of newspaper together and prepare a template from which to make an acetate or plastic cover over the entire assembly, extending from the mask board to the focus support and down to the baseboard at both sides. This arrangement has been proven virtually dustproof.

A small hole is required in the cover, adjacent to the EHT clip, on whichever side suits the constructor's layout. The cover should be reinforced around the hole with scraps of the same material glued on both sides. The hole is then fitted with a grommet of a size providing a tight fit to the EHT lead which is passed through it and soldered to the EHT clip. A suitable EHT lead is provided by stranded $\frac{1}{8}$ " coaxial cable, with the PVC outer covering and metal braiding stripped off.

Connections may now be made from the deflection assembly to the 7-pin connector, a record being kept of "which wires are soldered where."

At the rear of the cover, on either the right or left side of the top stay, cut out a hole of 4" diameter. This will enable adjustment of the deflecting coils for a vertical picture to be carried out without touching the live cone of the tube.

Clean glass, screen, and interior of assembly. Fix cover in position, and seal all joints with sellotape. A 5" piece of material may be lightly fixed over the 4" hole just mentioned until the time bases and electronic section are completed.

To be continued.

Components mentioned in this Article
Deflector Coils,

Allen Components, type DC300.

Focus Coil,
Allen Components, type SC302.

7-Pin Connector,
Standard Belling Lee, Bulgin, etc.

on the inside of the board. The ends of the batten must line up with the mask board. Fix metal angle brackets, and make sure there is no air space beneath the board and blanking batten.

Now place deflection coils on tube neck and gently slide focus board up to them until a slight pressure is exerted from the rubber around the tube hole. NOTE: this can be ascertained by gently rotating the coils until pressure is obvious. By this means, once the coils are set for a level picture they will stay in position.

Screw down brackets at rear.

The blanking-off fillets on the baseboard, Fig. 1 last issue, may be made and screwed down between the mask and rear boards. Fix top stay, cover photo last issue, making sure the front board is vertical.

Set up a bevel to obtain the angle of front to rear boards, and plane wooden edge fillets accordingly to provide a good seating for the final cover.

Mask Construction

Replace boards and top stay.

Wood angle fillets have already been fixed in position around the mask opening, Figs. 3 and 4—these should be marked across, dividing the opening into quarter sections, Fig. 6.

Next cut out a paper template—a rough idea of the shape is shown in Fig. 5. This template should fit snugly the radiused corners, and extend flush from front of mask board, conforming at the same time to the contour of the tube screen. This is quite simple to do; your writer achieved it at the first attempt.

Now carefully cut off $\frac{3}{8}$ " from the tube edge of the template; this will provide the air space mentioned in the last issue.

Fig. 6 explains the procedure very clearly. Try the template in all four quarter sections. If due care has been exercised, one template will do for all four sections.

Place the template on $\frac{1}{4}$ " rubber or plastic sheeting, and cut out four sections. Glue with suitable adhesive. Bostik was found to

The Final Circuit
The circuit which was used to take the oscillograms, then, boils down to that shown in Fig. 14. The valve is an SP61 (Service No. VR65 or CV118 or CV1075). This valve is an RF pentode but it is used here connected as a triode. The frequency of the crystals which were used was in one case 6560 kc/s, and in the other case, 5880 kc/s. I think that similar results could be obtained with any crystal. Fig. 15 shows the apparatus as it was set up, along with the coils which were used. The crystal oscillator is at the left on the vertical strip. This is fastened temporarily to the top of the cathode ray tube casing. The coils and variable capacitors are in front of it. There are two variable capacitors side by side on a small panel. This came out of a radar strobe unit, and as it had the necessary two capacitors and also some solder tags on a small rear panel it was just right for the job. The main coil has eighteen turns one inch in diameter and it is two inches long. The other coils have one, three, and five turns respectively and are also one inch in diameter.

The pick-up for showing the voltage waveform was taken directly from the upper end of the tuned circuit, as shown in Fig. 14. The

blocking capacitor, C₁, should preferably be a mica one, or if a paper capacitor is used then it must be picked out for its good insulation. Any leakage through this capacitor will drive the spot of the cathode ray tube across the screen, acting as though it were a shift potential. If the plates of the cathode ray tube are connected to the earthed side of the EHT circuit through a high resistance, as is usual, then a very small current indeed will suffice to drive the spot right off the screen. The current, or magnetic pick-up, was taken from a five turn coil, one end of which was connected to the earth point and the other end of which was connected directly to the cathode ray tube 'Y' deflection plate. This coil was wound as flat as possible so that it could be slipped in between the turns of a coil at any point. It was wound from insulated wire, of course. Its normal position is at the earthy end of the main coil. Here it suffers the least possible capacitive pick-up and it has the least possible effect on the circuit under investigation.

The panel at the rear is the Puckle time base, and the lower case holds two VCRI38 cathode ray tubes and their EHT potentiometers. Power was supplied from a bench power pack which is not in the picture. When

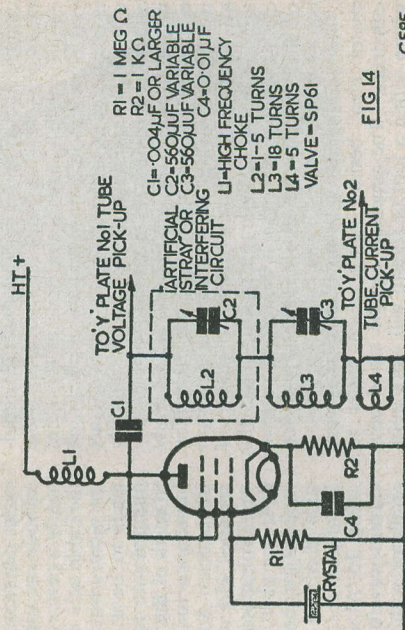

Fig. 14. Circuit used for taking the oscillograms illustrated in this article.

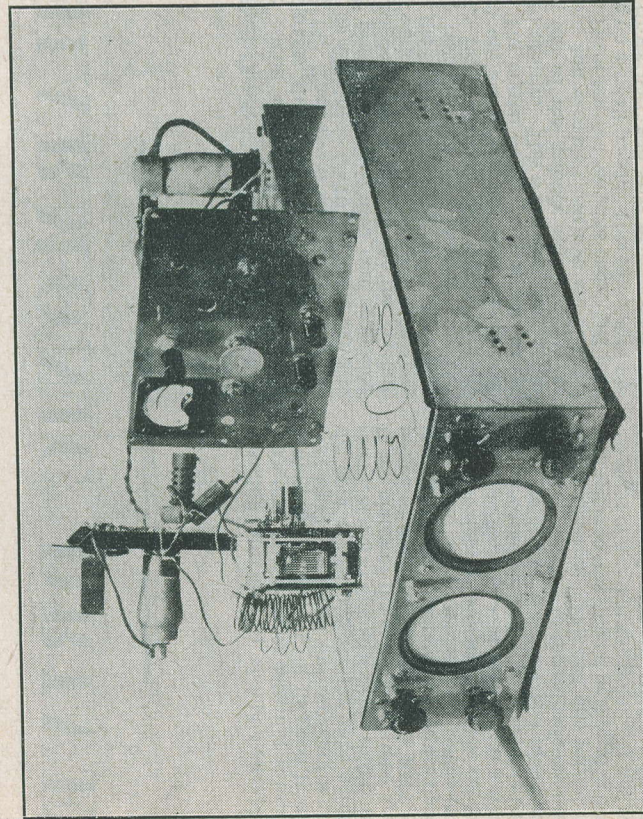

Fig. 15. Showing Fig. 14 as set up in practice.

two tubes are used in this manner, both being driven by one timebase, the result is similar to that obtained by using the Cossor double beam tube. It is not quite so easy to compare the phases of two waveforms, but it does make it much easier to investigate a circuit since the changes at two points may be observed simultaneously. This cuts out the wondering if the circuit is still behaving the same at the point you have just left, now that the oscillograph is connected to another point. Often the act of taking an oscillograph pick-up will radically alter the behaviour of a circuit, so it is very useful if one tube can be left permanently connected as a monitor, while the other tube is used as a roving 'eye', to scan the waveform at various points in the circuit. If the act of tapping in the oscillograph pick-up alters the circuit behaviour, the fact is immediately shown on the monitor tube and the necessary action can be taken.

An oscillograph split up into units is very useful also, besides being much easier to construct. The timebase can be stood anywhere within a foot or so and will work quite well, while the equipment under test can be

stood right over the cathode ray tubes and the connection to the deflecting plates made with only an inch or two of wire. This is a thing which is often of paramount importance.

It is of no use to employ screened cable to carry signals at frequencies of several megacycles per second to the deflecting plates of the cathode ray tube, unless the waveform is very nearly a perfect sine wave. The reason is that the cable acts in a similar way to a filter, and the picture which appears on the screen always tends to be a sine wave, no matter what is pumped into the other end. The capacitance to earth of the cable has a progressively lower impedance to progressively higher harmonic frequencies, and if seven or eight inches of screened wire were used most of the distortion would disappear before the signal reached the deflector plate. One must always be on the lookout for that sort of thing. A cathode ray tube is a very useful thing, but it can tell a lot of lies.

Fig. 16 'A' and 'B' shows the voltage and current waveform, respectively, of the crystal oscillator with just a single coil and variable capacitor in the anode circuit. The current

'artificial strays.' It is possible to obtain the same results by using long, untidy connections between the coil and earth and between the coil and the anode of the valve, instead of a second tuned circuit, but the results are not so easily repeated nor are the conditions so stable. It does show, however, that strays really do produce these deviations from sine wave conditions in the oscillatory circuits. The large harmonic distortion shown in Fig. 17 is third order harmonics are also represented. The three turn coil was capable of producing many different patterns. A single picture gives no idea of the great variations which are produced as the 'interfering circuit' is tuned up and down. The two patterns shown were visible simultaneously, it should be said, one on each tube.

Fig. 18 'A' and 'B' shows the voltage and current waveform when the 'interfering coil'

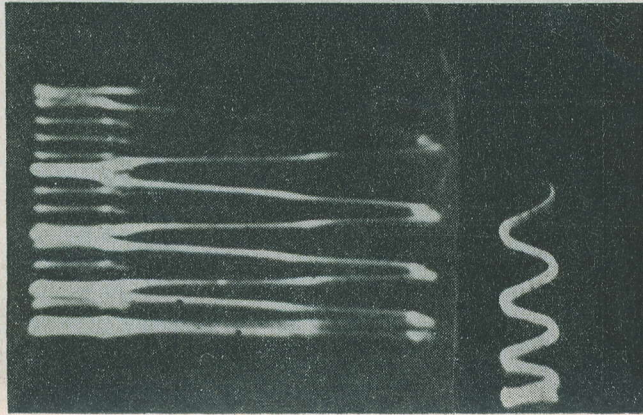

Fig. 16 A. (top). Fig. 16 B. (below)

waveform is very nearly a sine wave, though it showed evidence of harmonic distortion as a series of tiny ripples superimposed on the main waveform. Although the ripples were quite plain on the screen they have probably been lost in the process of photographing and block-making. After all, the original trace was only just over one eighth of an inch high!! This is a pointer, by the way. If you have an oscillograph with a three inch screen, especially if you are using a VCR138, do not yearn for a bigger one. It is very doubtful if it will give better traces, and it may give much worse ones. It is more expensive to buy and much more bulky and difficult to instal. The EHT applied to the tubes which gave these oscillograms was only 1200 volts, using the 700 volts from across an ordinary 350-0-350 transformer and four 150 'pencil' rectifiers as a voltage doubler.

Fig. 17 'A' and 'B' shows the voltage and current waveform with a coil of three turns tuned by one of the 560µF variable capacitors, and connected in series with the main oscillatory circuit as shown in Fig. 14, to provide

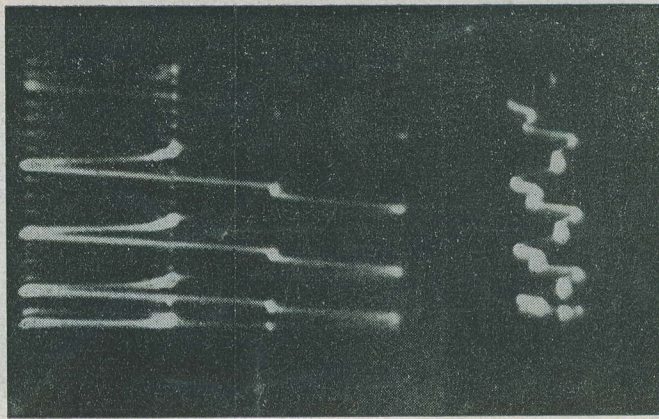

Fig. 17 A. (top)
Fig. 17 B. (below)

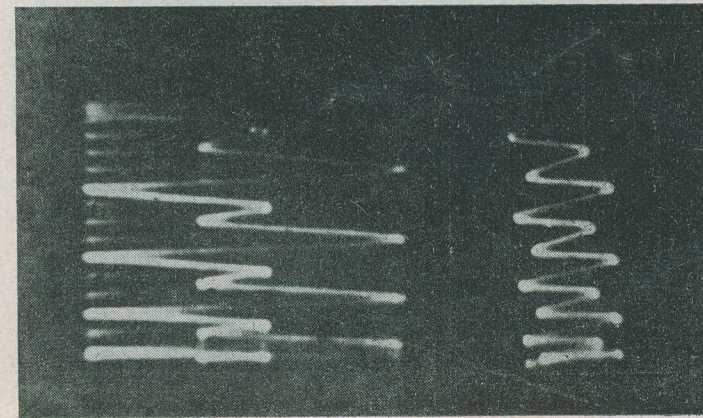

Fig. 18A (Top).
Fig. 18B (Below).

was given five turns. This is a very distinct and easily recognisable second harmonic distortion. Fig. 19 'A' and 'B' shows the voltage and current waveform when the capacitor setting for Fig. 18 was changed by about three degrees of rotation. The main distortion is still second harmonic, but it is now in a different phase relationship to the fundamental.

Fig. 20 'A' and 'B' shows the voltage and current waveform respectively when the coil in the 'interfering circuit' had only one turn. A rather odd thing occurs here. It is possible to count five subsidiary fluctuations in the voltage waveform, but only four in the current waveform. This is due, I think, to the fact that the voltage waveform is taken from the upper end of the interfering coil (in effect from the anode of the valve) while the current waveform is taken from the earthy, or lower, end of the main coil.

Fig. 21 shows a somewhat similar waveform, ill using one turn, but here there are five

smaller peaks on the current waveform and five, with an incipient sixth, on the voltage waveform.

On some of these oscillograms you may notice, if it survives the blockmaking, a peculiar marking consisting of two or three light strokes between each peak of the voltage waveform. This is because these oscillograms were not taken in the orthodox manner. Normally, one attempts to get a trace during what is called the working stroke of the time-base and to suppress the flyback. Here the opposite is done. The cathode ray tube is brightened during the working stroke and is left normal during the flyback stroke. The result is that the waveform to be examined is shown on the much faster portion of the time base. In this case the flyback is about three times as fast as the working stroke, and the time base is working at about 350 kc/s, so that the effective speed of the time base is over 7 Mc/s.

Now, Mr. O. S. Puckle's timebase circuit, even when constructed from any old valves and components (like mine is), will go up to

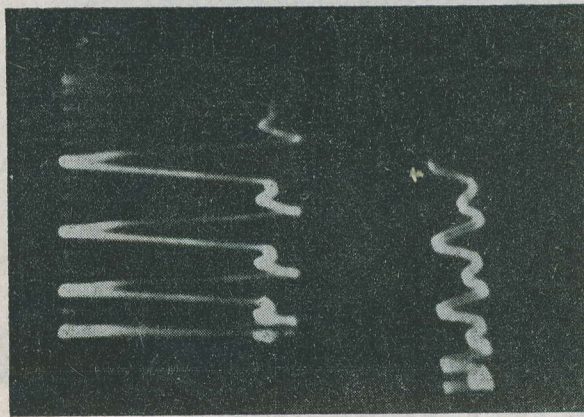

Fig. 19A (Top).
Fig. 19B (Below).

much as forty volts, and the timebase is, therefore, very stable. Most of the traces shown could be held sufficiently stationary for visual purposes for an hour or more if necessary. A very slight 'jiggle' limited photographic exposures to about fifteen seconds. This 'jiggle' appears to be due to irregularities arising inside the timebase valves. It is probably the visual counterpart of our old friend 'valve noise.' The 'jiggle' is not noticeable to the eye until the trace is examined through a magnifying glass, but it causes a mysterious apparent loss of focus when photographing, especially on complicated traces.

Conclusion

It is hoped that this circuit will be of some assistance not only in grasping where tuned circuit harmonics come from, but also in practice. As can be seen from the oscillograms, it is possible to obtain quite large amounts of harmonic distortion, and this in a circuit which is quite safe so far as the crystal is concerned. Some crystal oscillators when arranged for

continued on p. 330

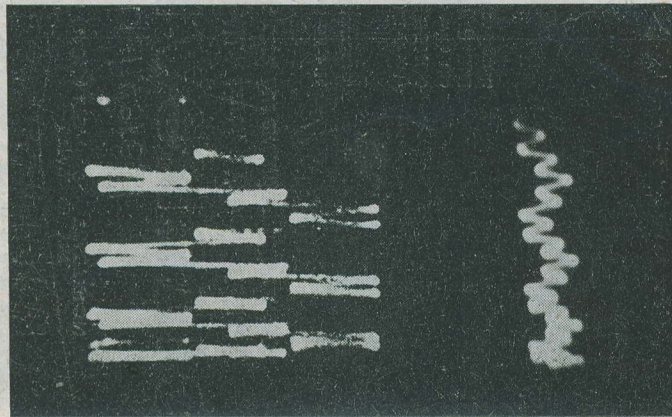

Fig. 20A (Top).
Fig. 20B (Below).

300 or 400 kc/s easily. It is not quite so easy to go up to a megacycle per second, however. The circuit will do it, to be sure, but the design and construction are matters of some moment at these frequencies. By using the technique which I have outlined it is possible to use a Puckle timebase at high frequencies without going to a deal of expense.

When one considers that the superimposed ripple on the waveform of Fig. 20 'B' represents a frequency of 23.52 Mc/s, while that on Fig. 20 'A' or Fig. 21 'A' or 'B' represents a frequency of 29.4 Mc/s, it is realised that quite useful results can be obtained from simple equipment. Incidentally, the spot velocity along the X axis (horizontally) during the trace was approximately one and a half inches per micro second.

The time base was fed from a voltage stabilised power pack having an 807 series stabilizer valve, an EF50 shunt differential amplifier and a VR105/30 reference valve. This power pack changes its output voltage by only about 0.5 volt if the input changes by as

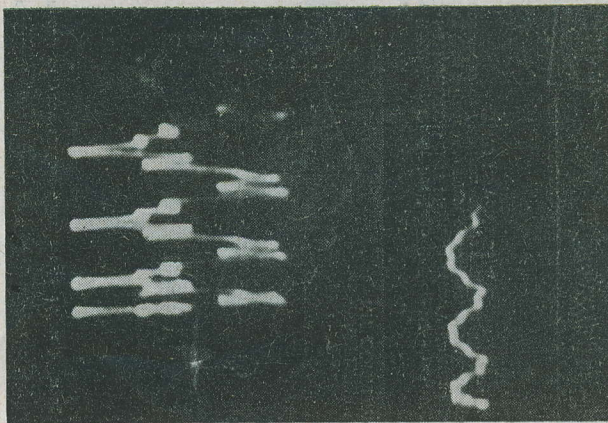

Fig. 21A (Top).
Fig. 21B (Below).

PREMIER (REGD.) **RADIO** ESTAB. 40 YRS. TELEVISION **RADIO COMPANY**

B. H. MORRIS & CO. (RADIO) LTD.

Now being Delivered!

PREMIER MAGNETIC-

£29 - 8 - 0

Including ALL parts, Valves, Cabinet, Loudspeaker, etc., but excluding Microphone.

(Carriage and Packing 15/-)

To those unable to build this TAPE RECORDER we can offer it completely wired and tested at £34.8.0d. plus £1.1.0d. Insurance, Packing and carriage.

The kit incorporates the NEW MODEL LANE TAPE TABLE already assembled and ready for use, a 6-VALVE SPECIALLY DESIGNED AMPLIFIER KIT including Bias and Erase Oscillator for use with the above unit and a WELL MADE WALNUT FINISHED TABLE CABINET to house the complete unit. Outside dimensions when closed: Height 13½ in., Length 17in., Depth 13½ in.

SPECIAL FEATURES of the Amplifier include separate Bass and Treble lift controls, high and low gain Input Sockets, Record/Playback indicator, etc. May be fed from Microphone, pick-up or directly from the Speaker terminals of your radio. Chassis size 14" x 9" x 2½".

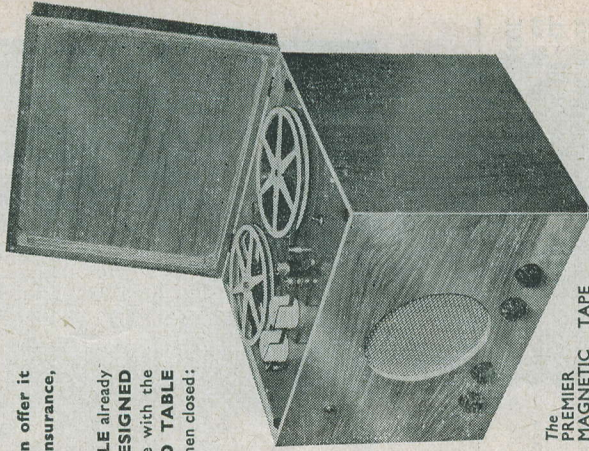

The PREMIER MAGNETIC RECORDER TAPE KIT

WHEN COMPLETED, COMPARES FAVOURABLY WITH ANY OTHER COMMERCIAL MODEL

INSTRUCTIONAL BOOKLET 2/6

This is credited if a complete Kit of the Tape Recorder is ordered

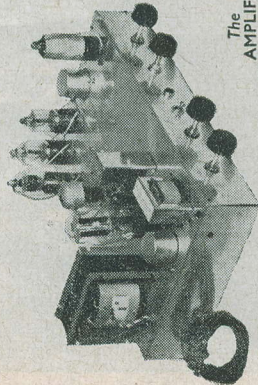

The AMPLIFIER KIT COMPLETE

This Recording Outfit has been designed for use with M.C.-1-111 SCOTCH BOY Magnetic Tape. With this high quality tape a frequency range of 50 c.p.s. to 9,000 c.p.s. at a tape speed of 7½ in./sec. can be readily achieved. 1,200 ft. reels 35/-

OPEN UNTIL 6 PM ON SATURDAYS

THIS IS OUR ONLY ADDRESS

207 · EDGWARE ROAD · LONDON · W.2

Telephones: AMBASSADOR. 4033 PADLINGTON. 32717/2

TERMS OF BUSINESS: Cash with order or C.O.D. over £1. Please add 1/- for Post. Orders under 10/-, 1/- under 40/-, unless otherwise stated.

IMPORTANT ANNOUNCEMENT: WE CANNOT ACCEPT RESPONSIBILITY FOR, NOR CAN WE GUARANTEE ANY KIT OR COMPONENT SOLD AS A PREMIER PRODUCT BY FIRMS OTHER THAN OURSELVES

PREMIER (REGD.) **RADIO** ESTAB. 40 YRS. TELEVISION **RADIO COMPANY**

B. H. MORRIS & CO. (RADIO) LTD.

Now being Delivered!

-TAPE RECORDING KIT

SPECIFICATION of the NEW LANE TAPE TABLE.— Made to high standards and incorporating features ensuring low level of "Wow" and "Flutter" throughout the full length of tape.

FAST REWIND. Provision for fast rewind and forward run in less than 1 min. in either direction. Three motors obviating friction drive.

HIGH FIDELITY RECORD PLAYBACK. (1 hour approx. playing). The Table is fitted with high fidelity record play-back head of new design wound to high impedance and a separate A.C. Erase Head. The Heads are half track size allowing approx. 1 hr. playing from standard 1,200ft. Reel of Tape.

PREMIER AMPLIFIER KIT INCLUDING 8in. SPEAKER

£7 19s. 6d.
2/6 packing and carriage.

£16 10s. 0d.
7/6 packing and carriage.

5/- packing and carriage.

WORKING MODELS OF THIS KIT CAN BE SEEN AT THE ADDRESS BELOW

LUSTRAPHONE High Fidelity Microphones are especially recommended for use with the Premier Magnetic Tape Recording Kit.



HAND Microphone £6. 6. 0.

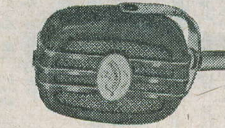

The slightly rising frequency response together with freedom from distortion makes these microphones especially suitable for transmission of speech, whilst the general frequency characteristic which is entirely free from pronounced peaks, allows the instrument to be most satisfactorily used for recording purposes.

All exposed surfaces are either chromium plated or stove enamelled, contributing to the generally attractive appearance of these microphones.

SPECIAL FEATURES of the HAND MICROPHONE: The case has been "tailored" to follow the form of the user's hand and is ruggedly constructed as a pressure die casting in order to withstand the rough treatment to which hand microphones are usually subjected. The switch is conveniently located for ease of operation and can be arranged to act as a spring-loaded and/or locking device.

BOTH MODELS CAN BE SUPPLIED FROM STOCK

WE CORDIALLY INVITE YOU TO VISIT OUR STAND AT THE

'DAILY MAIL' IDEAL HOME EXHIBITION
CHILDREN'S SECTION (Ground Floor) + OLYMPIA
Where the PREMIER MAGNETIC TAPE RECORDING KIT, and BABY ALARM KIT, will be exhibited and demonstrated.

STAND No. 210
Table Stand £2. 7. 6.
Microphone £5. 12. 6.

OPEN UNTIL 6 PM ON SATURDAYS

THIS IS OUR ONLY ADDRESS

207 · EDGWARE ROAD · LONDON · W.2

Telephones: AMBASSADOR. 4033 PADLINGTON. 32717/2

TERMS OF BUSINESS: Cash with order or C.O.D. over £1. Please add 1/- for Post. Orders under 10/-, 1/- under 40/-, unless otherwise stated.

TEE ANY KIT OR COMPONENT SOLD AS A PREMIER PRODUCT BY FIRMS OTHER THAN OURSELVES

KIT REVIEW

I. The Premier Magnetic Tape Recording Kit

[Premier Radio Co., 207, Edgware Road
London, W.1.]

This is a well-designed kit consisting of three units, each of which may be purchased separately.

Lane Tape Table

This is completely assembled and ready for use. The mechanism is well made and robust. Flutter is reduced to a minimum by the use of a heavy flywheel. A single motor is employed, and this is a heavy duty type to ensure ample power, and consequent steady speed of the tape across the head. Two separate heads are employed for record/playback and erasure. Each is fitted with a mumetal shield to concentrate the field and prevent external hum pick-up. High impedance heads are employed, and double tracking allows of an hour's recording from a standard 1200-ft. reel of tape (tape speed is $7\frac{1}{2}$ " per sec.). The deck is finished in stove enamel, and is priced at £16 10s. 0d., plus 7s. 6d. packing and carriage.

Table Cabinet

This is a neat and attractive job, and is finished in walnut. Price is £4 18s. 6d., plus 5s. carriage and packing.

Amplifier Kit

As will be seen from the circuit diagram, a VR65 is used in the first stage, which is used for playback and low input recording. High level inputs are fed into the grid of the second stage, which employs a 7193 triode. The final recording stage, V3, is built around a further 7193. On playback, a further stage of amplification, V4, a VT501 output pentode, is brought into operation. A VT501 is also employed as the Bias Oscillator, V5, in a straightforward Hartley circuit. The power pack is for AC mains, and comprises mains transformer, full wave rectifier, and single filter unit.

The kit is supplied complete with punched chassis, 8" speaker, nuts, bolts and every item needed to complete construction, at £7 19s. 6d. plus 2s. 6d. packing and carriage.

Component Values

R1	470 kΩ
R2	22 kΩ
R3	270 kΩ
R4	2.2 kΩ
R5	1 MegΩ
R6	500 kΩ Potentiometer
R7	47 kΩ
R8	10 kΩ
R9	22 kΩ
R10	47 kΩ
R11	1 kΩ
R12	250 kΩ Potentiometer
R13	150 kΩ
R14	470 kΩ
R15	220 kΩ
R16	22 kΩ
R17	500 kΩ Potentiometer
R18	47 kΩ
R19	1 kΩ
R20	680 Ω
R21	10 kΩ
R22	22 kΩ
R23	190 Ω
R24	15 kΩ
R25	68 kΩ
R26	470 kΩ
C1A/B	16-16 μF 350 V.W.
C2A/B	16-16 μF 350 V.W.
C3	500 pF
C4	50 μF 12 V.W.
C5	0.1 μF
C6	0.1 μF
C7	50 μF 12 V.W.
C9	50 pF
C10	0.1 μF
C11	0.005 μF
C12	0.1 μF
C13	1600 pF
C14	0.1 μF
C15	0.1 μF
C16	25 μF 25 V.W.
C17	1600 pF

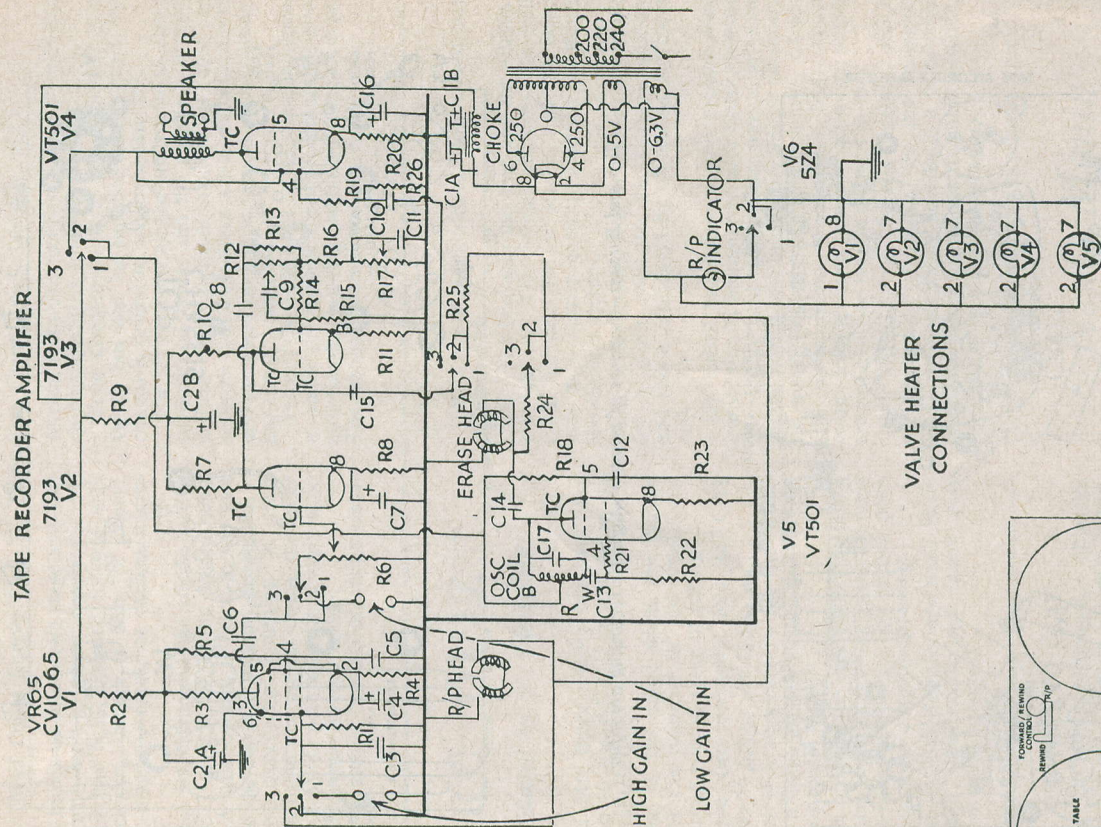

VALVE HEATER CONNECTIONS

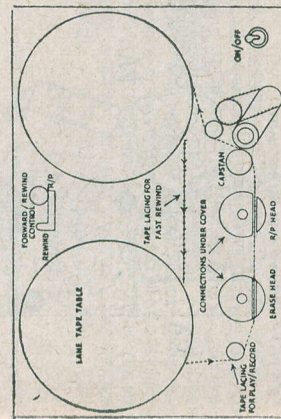

LAYOUTS ON NEXT PAGE

2. The M.O.S. Amplifier, Type A1

(Mail Order Supply Co., 33, Tottenham Court Road, London, W.1.)

This kit builds up into a two stage amplifier complete with built-in power supply for AC mains, and has been designed for use with crystal pick-ups, though it also, of course, caters for magnetic types, or carbon microphones.

The input stage employs the triode section of an EBC33 or 6Q7 DDT, the diodes being ignored. A gain control is fitted in the grid circuit, and the anode is suitably decoupled. Resistance-capacitance coupling is used between the input and output stages, the latter employing a 6V6G pentode with a multi-ratio output transformer in the anode.

The power supply consists of mains trans-

former, full-wave rectifier (5Z4 or 5U4G) and choke/capacitors smoothing filter.

Tone compensation is not normally provided, but can be supplied as an extra; the chassis is drilled to accommodate this.

The kit contains all the items needed, down to nuts and bolts, and the chassis is already drilled. One unusual feature is that all resistors and capacitors are already mounted and pre-wired on a group board, thus simplifying construction.

Price of the outfit is £4 2s. 6d., which includes a useful instruction manual containing constructional, operating and fault-finding sections. The manual by itself costs 3s. 6d.

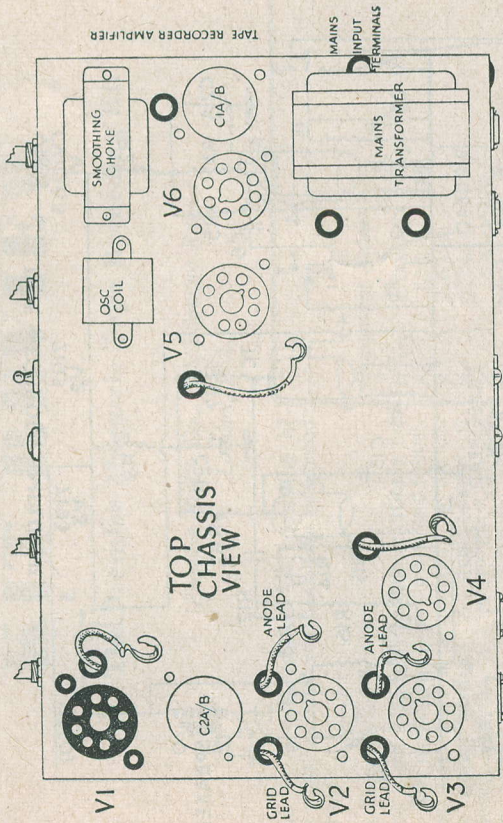

Top and Bottom—Layouts of premier magnetic recording amplifier

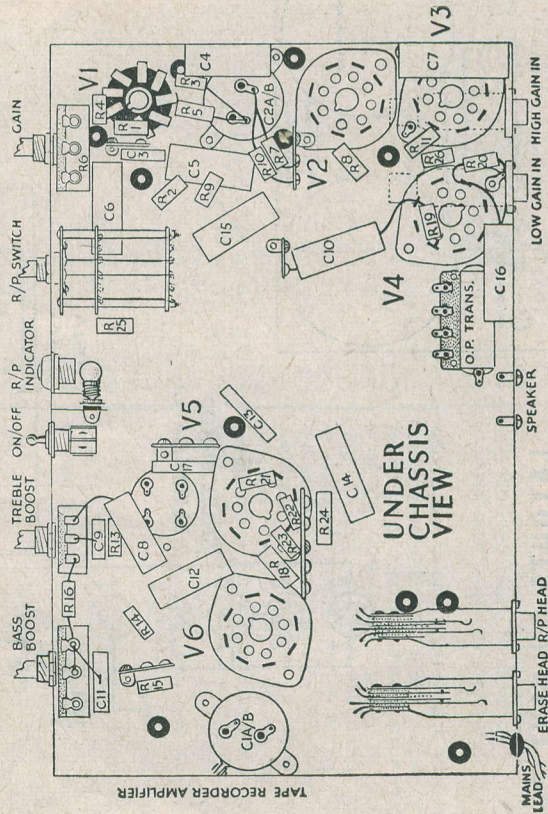

“RC QUIZ”

Conducted by W. GROOME

- (1) Did Mr. Brain choose the hard way in deciding to use AC/DC technique in an experimental television?
- (2) What is the effect upon the picture of reducing the diameter of the dipole, say by substituting wire in place of tubing?
- (3) Name two methods used in CRT manufacture to reduce ion burn.
- (4) Why is it necessary to tilt the deflection coils a little off horizontal in order to obtain a horizontal raster?
- (5) Is it possible for carelessness in fitting a loudspeaker in its cabinet to cause the cone and voice coil to move from its central position and to cause distortion?
- (6) What kind of particles are most likely to be found adhering to the centre pole and plate of a loudspeaker?

ANSWERS TO QUIZ

(1) Yes. AC/DC technique, although perhaps permitting of a more compact layout, has far more disadvantages than an AC only job where an experimental television is concerned. One such is the series heater chain, and the necessity of connecting an expensive CRT into it. Another is the low HT supply, and the fact that no one section can be operated by itself, as is sometimes necessary when experimenting.

(2) Loss of definition, due to the reduction in bandwidth.

(3) The bent-gun ion trap and the aluminium screen. The former removes the ions from the path to the screen, and the latter acts as a barrier without seriously impeding the electron stream.

(4) The focusing ring or coil is responsible for a slight twist to the electron stream, and this is eradicated by off-setting the focus coil.

(5) Small loudspeakers with pressed steel frames should be mounted with equal pressure all around, and the holding screws or bolts should not be tensioned more than is necessary to avoid vibration, or loosening. Larger and more expensive speakers have much more solid frames, usually die-cast, which are not likely to buckle or bend in use.

(6) Particles of ferrous metals which are attracted, of course, by the magnetic field. It is surprising how large a percentage of ordinary dust can consist of these particles, particularly in industrial areas.

Next Month

MAINS OPERATED CAPACITANCE
RESISTANCE AND INDUCTANCE
BRIDGE — QUALITY AMPLIFIER.

Radio Miscellany

Just the Touch
 This, which for the want of a better term we call "feel," cannot be logically explained. Almost all of us must have met the craftsman who can accurately judge the quality of materials simply by handling them. May-be a baker who knows by the look and feel of a handful of flour just what sort of bread it will make, and how much water it will take to the sack, or the chef who can spot with absolute certainty the tender joint at a glance or gentle thumb pressure. They cannot explain how they "know," nor can they describe to what extent they depend on sight or other senses.
 Similarly, I have seen experienced radio repairers tell the cause of a particular type of background noise simply by listening. The unaccustomed ear can differentiate between intermittent and continuous crackling, or irregular bangs and rumbles, and most of us are able to reduce the cause to a half-a-dozen possibilities. But the real radio green-fingers detects a subtler difference and can identify the form of trouble almost instantly in models he has grown to "know."
 It seems that unless you are born with the gift you can never learn to do it by instinct, and even if you are born with it, it seems to need quite a bit of practice before it develops. The theorist's instincts are often blunted by too much theory and examination knowledge, and while the text-book gets him there just the same it takes much longer. Perhaps the man with the natural flair would be equally slowed down if, instead of "doing what came naturally," he tried to work to a book of rules.

Anodising
 I have several times commented on the many and varied activities to which our interest in radio leads us. The latest I have run across is the anodising of aluminium and its alloys. The method is one which uses AC and is fairly simple for home use, being in no way inferior to the DC process. It also has the advantage of doing two pieces (or two groups of small pieces) at the same time. Each piece, or group, is used as the opposing electrode, the terms anode and cathode being, of course, inapplicable to AC.
 The voltage is drawn from the AC mains supply via a 6 Amp transformer, giving 15 volts increaseable by tapping down a resistor to 25 volts. Pleasing decorative

When I was with the Services we had one such chap who had previously run a successful one man repair business. If it had been a private firm, and not the Army, he would have had the sack before the first week was up. He was hopelessly lost with strange and complicated apparatus, but within a few weeks he was doing the "sticky" ones—those in the corner over which a lot of time had already been unsuccessfully spent, and had been put aside until we were less busy. Once they got there, by the way, nobody else liked to take them on unless driven to it. He explained it quite simply by saying he had now got the "feel" of the sets. Most of us will know just what he meant by the "feel," but it baffles a more scientific description. True to form, he usually did badly on the various Courses on which he was sent, and I believe he even flopped in his first attempt on the trade test.

effects are obtainable by the use of ordinary household packet dyes, which give a "fast" colour that cannot be washed off with boiling water.

For the benefit of beginners, I might explain that the anodic oxidation of aluminium consists of depositing a film of aluminium hydroxide on the surface. While it gives considerable protection from corrosion, its protective value is often over-estimated for outdoor uses—such as in the elements of beam aerials, etc. True, it does give protection against atmospheric corrosion under normal indoor conditions, but its protection is far less permanent out of doors where it is subject to frosts and rain. The process is more frequently valued because it gives a greatly improved appearance by preserving highly polished surfaces. The anodic film, too, readily absorbs ordinary dyes, while it also provides an excellent surface to "take" cellulose lacquers.

Club Magazines

From time to time copies of duplicated Radio Club magazines reach me, and many of them are very good efforts. Unfortunately many of them, after a start showing much promise, soon flicker out of existence. Their failure is invariably due to apathy on the part of the members—not the members who read them but of those who should be helping to write them. The stalwarts who

shy, soften them up with a little flattery, and if they are tongue-tied, help them to write it. Warm them up on their pet subjects. Every Club has a meter expert, a keen TV builder, a gadget merchant, a high fidelity group, and the fellow who is always trying to build a midget small enough to carry in his vest pocket.

Other Points

On the non-technical side why not use the old, but ever fresh, idea of starting a "Looking back" series in which each member in turn tells how he first became interested in the hobby, his mistakes and failures and his successes. Of what wonderful equipment he would build if he had lots of time—and money. What sort of workshop he has to put up with, or boast about. How he conceals an unco-operative family or appeases his neglected XYL.

Plan the illustrations and circuits, and get someone who can do them well for the actual drawing.

Use a typewriter which will cut the stencils cleanly (preferably with a small face type) and hand-letter the headings boldly to suit the nature and the importance of the article. Incidentally, titles, etc., can be cut out of used stencils for subsequent issues, and odd cuts which would otherwise be wasted can also be put to good use for this purpose.

If your Club, as many of them seem to

CENTRE TAP talks about "GREEN FINGERS" - ANODISING - CLUB MAGAZINES

set off to an enthusiastic start gradually lose heart after many disappointments in their efforts to get suitable material from their fellow members.

This is a subject on which I can speak with some experience, having in the dim distant past been associated with a radio club magazine which, despite a flying start, flopped after a few issues. A second venture with another club (not strictly radio but an allied hobby) ran for well over 40 issues. Why the difference? It was not just luck—there were very solid reasons for it.

For some of the lessons learned from the first failure which helped to ensure success the second time. Don't wait for the contributions to roll in, and by that I don't mean for you to keep worrying your fellow members to simply do "something." Plan out what you want from them and then worry them if you must. If they are pen-

draws its members from over a wide area it is doubtful whether you can get more than a 50% attendance except for the very special evenings. Members who have missed meetings like reports of what they have missed.

Dates and times of future meetings should be given prominent display, and the more unusual events such as outings, party visits and general notices, should be accompanied by brief descriptions.

Finally, get a good production manager to look after the duplicating side of the magazine. One who has a flair for that sort of thing and who takes a pride in making clear, unsmudged copies with a minimum of waste.

A well-produced, lively Club News Sheet is a great help both in maintaining the Club spirit and stimulating local interest. It also makes the Secretary's job easier (and (Continued overleaf)

from our

Mailbag

Proposed Recording Club

Dear Sir,

We have had in the past some excellent articles on Magnetic Tape Recording, and I have myself followed these with great interest, having constructed and experimented in this sphere of radio for some time. There are, I know, many other readers who have the same interest as myself, and I am wondering if a Magnetic Recording Club can be formed, each member exchanging views on tape. Providing $7\frac{1}{2}$ per second speed is used, many an interesting discussion can be recorded. I might add that a 1200-ft. reel of tape by post costs only 4d. more than an ordinary letter.

If any readers are interested, will they please contact me by letter.—P. N. Hollis, 143 Lymington Avenue, Leigh-on-Sea, Essex.

(This is a most excellent idea, and should provide a great deal of enlightenment and fun, such as the BSWL had from their Travelling Folder during the war. With double track recording a group of six could have ten minutes each in which to record their views and comments, on one reel of tape which would be sent from one to the other in rotation—each member of the group having a limited time in which to record and pass on to the next person. With several groups in operation, complete "lectures" could be recorded and sent to groups in turn for presentation at "get-togethers." Other possibilities will occur to interested readers. Our view—well worth following up.—Ed.)

Can Anyone Help?

Dear Sir,

Have you any information or do you know where I could obtain it, on converting the Telecon Receiver YA4915 into a personal portable receiver for operating a loudspeaker. Your help in this matter would be much appreciated.—R. Guntrip, 7, High Street, Chepstow, Mon.

Sir,

As I have purchased the following:—

1. Supply Unit No. 1 Mk. 1 for Wireless Set No. 19.
2. Power Unit Type 301 A.M. Ref. No. 10K/946.
3. Power Unit Type 602 A.M. Ref. No. 10KB/6153.

4. Receiver Type R3002, Ref. No. 10DB/1.
5. Receiver Type 1082 (Uses plug-in coils).
6. Receiver Type R1124D, Ref. No. 10D/1029.
7. Amplifier Unit Type A3562A, Ref. No. 10UB/60/8.

Would you please inform me if it is possible to get the circuits of same, also cost.

I would appreciate your assistance.—W. N. Hall, 239 Forest Road, Loughborough, Leics.

RADIO MISCELLANY.

Continued from previous page.

often cheaper) by avoiding the need for him to prepare and send out frequent circulars. If you can persuade local dealers to display publicity copies it can also serve as a first-class means of recruitment of new blood.

Another useful idea is to include among the supporting features a review of the leading articles to be found in the current radio journals. Few hobbyists buy them all, and they can thus be assured of not missing items of special interest to them. Occasionally Editors of professional periodicals are sympathetically inclined to bona fide amateur group magazines, and may permit reproduction of extracts of articles in past issues subject to the usual acknowledgment. Don't omit to ask first!

The Editor and I are, of course, always interested to see copies of Club and Group magazines, and we shall be especially pleased to see any new ones that may come into being as a result of this encouragement.

HARMONIC DRIVE.

Continued from page 321.

frequency multiplication cannot be tuned to the fundamental, otherwise the crystal is called upon to pass a heavy current and dissipate a large amount of power. This may damage or even destroy it. Often it is impossible to know that the circuit is in this state until it is too late to save a badly 'fried' crystal.

It should be said, of course, that it is not in the least necessary to have an oscillograph to investigate, to some extent at least, such a circuit as this. Much can be done by checking the harmonic drive produced at a receiver at various harmonic frequencies for various coils and capacitor settings, though the procedure is rather laborious and not nearly so instructive or so interesting as making use of an oscillograph.

THE MODERN BOOK CO.

- The De Luxe Home-built, Telesvisor and Radiogram.** By W. I. Flack. 6s. 6d. Postage 4d.
- Reference Data for Radio Engineers.** Edited by W. L. McPherson. 7s. Postage 6d.
- Amplifiers.** By N. H. Crowhurst. 3s. 6d. Postage 3d.
- Resistance Strain Gauges.** By J. Yarnell. 12s. 6d. Postage 6d.
- Handbook of Line Communication, Vol. 1.** The Royal Signals. 20s. Postage 1s.
- Theory and Design of Valve Oscillators, Vol. 7.** By H. A. Thomas. 2nd rev. edn. 36s. Postage 9d.
- The Radio Amateur's Handbook.** By The American Radio Relay League. 28th edn. 22s. 6d. Postage 1s.

- Theory and Design of Television Receivers.** By S. Deutsch. 55s. 6d. Postage 9d.
- Telecommunications Principles.** By R. N. Renton. 37s. 6d. Postage 9d.
- Time Bases (Scanning Generators).** By O. S. Puckle. 2nd rev. edn. 30s. Postage 9d.
- Television Receiving Equipment.** By W. T. Cocking. 3rd edition. 18s. Postage 6d.
- Radio Servicing: Theory and Practice.** By A. Marcus. 35s. Postage 9d.
- Radio Valve Data.** Compiled by "Wireless World." 2nd edn. 3s. 6d. Postage 4d.
- Radio Installations.** By W. E. Pannett. 45s. Postage 9d.

We have the finest selection of British and American radio books in the Country.

19-23 PRAED STREET, (DEPT.) LONDON, W.2

PADDINGTON 4185.

Complete list on application.

METAL WORK

with a difference!

if you want a well-made, attractive and robust cabinet for that receiver or transmitter; if you need a chassis for a modulator, amplifier or converter; in fact, if you need any metalwork at all for your ham requirements

YOU CAN DO NO BETTER THAN TO WRITE US FOR AN ESTIMATE

All metal work "made to measure"

For full details and address of nearest agent, contact—

L. J. PHILPOTT (G4BI)

(E. J. PHILPOTT)

Chapman St., Loughborough

Telephone: 2864

Do you value your . . .

TELEVISION SET?



Do you realise that you could be held responsible if your SET or your AERIAL caused injury or damage?

A "SCOTTISH" policy will cover damage to your RECEIVER, your liability for injury to Third Parties, and damage to your own property by the aerial FOR AS LITTLE AS 7/6d. A YEAR?

Send for Details to

Scottish Insurance Corporation Ltd.
62/63 Cheapside, London, E.C.2

THE CHEAPEST RADIO SHOP

"In Town"

SOLIDAS LTD.

4 PRAED STREET, W.2. Tel: AMB 4670
JUST OFF EDGWARE ROAD

BC 950 100-144 MC Transmitter Less Valves 17/6;
Canadian MK. 58 Trans-Receiver £12 complete;
B 36 £10.

POSTAGE EXTRA ON ALL ORDERS.

Slow Motion Drive with 1 1/2" drum attached 2/-;
4 way Push Button unit with buttons and plate 2/6;
40 ohm Moving Coil Mike. 5/-; Medium and Long
Wave TRF Coils 5/- pair; Midset S/HET Coil Pack
short and medium waves 8/6; U.S.A. type Push-Pull
tube Trans. O.K. for 6L6-KT66. £1 0 0; 150 MA,
350-0-350-6.3 5V. Trans. £1 0 0; Mains inser-
tor suppressor. 7/6; very effective 10,000 ohm
relax. 20 A.H. Glass Accumulator 4/6; 24 volt
small motor AC-DC Double Spindle 9/6; 230 volt
motor AC-DC with 3 speed gearbox 19/6; Volt
meter 30-0-30-3-0-3V. DC., 10/- with test
lead.

Come to SMITH'S of EDGWARE ROAD,
the friendly shop for

We stock everything the constructor needs—our 25 years
experience of handling radio parts and accessories enables us
to select the best of the regular lines and the more useful
items from the surplus market in—

- Loudspeakers and Phones
- Transformers and Chokes
- Pickers and Turntables
- Switches and Drums
- Books and Tools
- Valve Holders and Cans
- Metal Rectifiers
- Valves and CR Tubes
- Cabinets and Cases
- Capacitor and Resistors
- Coils and Formers
- Plugs and Sockets
- Arrials and Inductors
- Motors and Generators
- Wires and Cables
- Panel Lights and Fuses
- Recorders and Parts
- Sleeving, Nuts and Bolts, Tags, Clips, Grommets
and all other bits and pieces

NOTHING TOO LARGE—

NOTHING TOO SMALL

Everything you need under one roof—including all the parts
specified for the popular "Viewmaster" Home-built
Television, both London and Birmingham models.
No general catalogue is issued owing to constantly varying
stocks and prices, but we shall be pleased to quote you

H. L. SMITH & CO., LTD.
287/9 Edgware Road, London, W.2

Telephone: Paddington 5891
Hours 9 till 6 (Thursday, 1 o'clock)
Near Edgware Road Stations, Metropolitan and Bakerloo

**FIRST-CLASS TELEVISION
and RADIO COURSES**

GET A CERTIFICATE!

After brief, intensely interesting study—under-
taken at home in your spare time—YOU can
secure your professional qualification or learn
Servicing and Theory. Let us show you how!

FREE GUIDE

The New Free Guide contains 132
pages of information of the greatest
importance to those seeking such success-
ful and compelling qualifications as

- A.M.Brit.I.R.E. City and Guilds
- Final Radio, P.M.G. Radio Amateurs'
- Exams., Gen. Cert. of Educ., London
- B.Sc.(Eng.), A.M.I.P.E., A.M.I.Mech.E.,
- Draughtsmanship (all branches), etc.,
- together with particulars of our remark-
able Guarantee of

SUCCESS OR NO FEE

Write now for your copy of this invaluable
publication. It may well prove to be the
turning point in your career.

FOUNDED 1885—OVER

150,000 SUCCESSSES

**NATIONAL INSTITUTE OF
ENGINEERING**
(Depts. 466), 148, HOLBORN, LONDON
E.C.1.

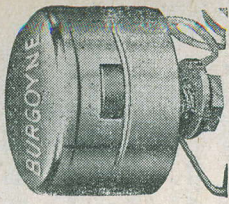

**The BURGOWNE
MAGNETIC
RECORDING
HEAD**

High Impedance
Positive Fixing Method
Half Track Width
Totally Enclosed With
Tape Guide
Wide Frequency Range

A competitively priced
Head equal to the best.
Ample supplies in stock
for manufacturers etc.

Record/Playback and Erase Heads
giving first class frequency response.

M.O.S. E&G MAIL ORDER SUPPLY CO.
The Radio Centre
33, Tottenham Court Road
London, W1

39/6

**FOR SUPERIOR
PERFORMANCE
AT LOWER
COST**

Distributed
exclusively by M.O.S.

1951 EDITION

**THE
RADIO AMATEUR'S
HANDBOOK**

Published by the A.R.R.L.
Price 22/6 postage 1/-

THE MODERN BOOK CO.
197/1, Praed Street, London, W.2.
Dept. RC
Tel.: PADDINGTON 4185

ADCOLA
(Regd. Trade Mark)

SOLDERING INSTRUMENTS



Reg. Design No. 860302
(British, U.S. and Foreign Patents)
Designed for wireless assembly and main-
tenance. Supplied for all volt ranges from 67V
to 230/250V. High Temperature. Quick
Heating. Low Consumption. Light Weight.
3/16" Dia. Bit Standard Model 22/6
1/4" Dia. Bit Standard Model 25/6
3/16" Dia. Detachable Bit Type 30/6
Sole Manufacturers: ADCOLA PRODUCTS LTD.
General Offices and Works: Cranmer Court,
Clapham High St., London, S.W.4. (MAC 4272)

Convert that old
Gramophone
OR OBSOLETE RADIOGRAM
into a
**MODERN All-WAVE
RADIOGRAM**
or POWERFUL RECORD PLAYER

Our "Skyway"
DESIGNS! Book gives full details
on how to build FOUR first-class
Amplifiers and Radiogram chassis. No
radio experience is required to un-
derstand the clear circuit diagrams
and stage by stage wiring plans.

All parts and materials are
easily obtainable—without
need for special tools. Performance £100
radiograms costing over £100

POST FREE
only from

High RADIOGRAM Ltd
69-71 Church Gate, Leicester LD1
PHONE 59527

26

SMALL ADVERTISEMENTS

Reader's small advertisements will be accepted at 2d. per word, minimum charge 2/-. Trade advertisements will be accepted at 6d. per word, minimum charge 6/-. If a Box number is required, an additional charge of 1/- will be made. Terms: Cash with order. All copy must be in hand by the 12th of the month for insertion in the following month's issue.

PRIVATE

FOR SALE. Canadian 58 Mk 1, TX/RX, Powerpack, Accumulators, Spare Valves, Accessories. New £12/10/0. Flat 2, Odeon Parade, Croydon Road, Beckenham, Kent.

WANTED. All issues Vol. 1, No. 1 to Vol. 4, No. 12 inclusive Radio Constructor. Odd copies accepted if series unobtainable. Details to Berry, Brynhyfryd Villa, Ruabon, Denbigs.

FOR SALE. "Radio Vision" V5SR (R1155) internal power/output, external speaker, new cases, £12. Universal Avonminor with case, £5. Two small Murphy Sutton pre-amps less 10F1 valve. Wanted recent Avo Model 7. Holden, 430, Burnley Road, Waterfoot, Lancs.

FOR SALE. MCRI 15-2000 metres and 7/5/0. 1224A 30-300 metres £5/0/0, or offers, both perfect. Also other useful gear, write for list. Box No. B 180.

FOR SALE. Avo Valve Tester. New condition, complete with up to date Avo Valves Manual. Guaranteed perfect, £15/15/0. Steel, 19, Spur Road, Orpington, Kent.

FOR SALE. 15 watt Lexington Amplifier, complete with valves, spares and Goodmans 12" speaker, £10. Conner, 34, Victoria Park Road, Hackney, London, E.9.

FOR SALE. Short Wave News Dec. 46 to April 49. Radio Constructors Aug. 47 to April 49, 45/-. Many other periodicals. SAE to G3FPK, 79, Murchison Road, London, E.10.

WANTED. Avo Model 7 Meter. State price. Howard, 58, Kingsley Avenue, Southall, Middx. £60/9/-, or exchange for 6SR7 and 6SK7. Box No. B 181.

FOR SALE. R1155 RAF receiver £10. Craig, 100, Myddelton Road, High Street, London, N.8.

FOR SALE. Copies Radio Constructor and Short Wave News Dec. 1949 to Dec. 1951, also Radio Handbook 12th Edition, offers. Rawlings, 19N Peabody Buildings, Southwark Street, London, S.E.1.

WANTED. General purpose Signal Generator, Anderson, 29, Vaughan Road, Thames-Ditton, Surrey.

FOR SALE. Qualtape desk, 1 reel EMJ tape, Acos M.I.C. 22-2, all as new. Sell or exchange 3 speed Auto-changer or what have you. Freeman, 14, Orchard Green, Beccles, Suffolk.

WANTED. R1155 in working order, appearance no consequence. Offers to ISWL/G4971, 83a, Downscourt Road, Purley, Surrey.

FOR SALE. Radiocraft DX2 Valve, mains. Bought new 2 months ago. £5/5/0. Hall, 66, Cornwall Road, Ruslip, Middlesex.

OFFERS. R1355 and RE25 modified vision receiver, working and aligned. What offers? H. D. Ford, Great Bramston Farm, Fleet, Hants.

FOR SALE. Co-Axial cable, 11 yards approx. 7/6 carriage paid. 21c offered for Radio Constructor dated January 1949. Miles, 34, Shenstone Road, Birmingham, 16.

TRADE

"PANL"—the air drying black crackle for the amateur. 5/6d. per 1 pt. can, from L. Miller, 8, Kenton Park Crescent, Middx.

TV COILS. ALL TYPES.—Bell Sound Products Co., Marborough Yard, London, N.19. ARC 5078.

E. M. I.

JOB or HOBBY.—Whichever it is in Radio or Television, we can help you. Backed by the great E.M.I. organisation, we can offer the most authoritative and up-to-the-minute Home Study courses in Radio, Television and Electronics. **FREE BROCHURE** from E.M.I. INSTITUTES, Postal Tuition Division, Dept. R.C.11, 43, Grove Park Road, Chiswick, London, W.4. Chiswick 4417.

JOIN THE ISWL. Over twenty free services to members including QSL Bureau, Translation, Technical and Identification desks. Dx certificates, contests and activities for the SWL together with over seventy local Groups in this country. Monthly magazine 'MONITOR', twenty pages plus cover, duplicated, containing articles of general interest to the SWL and League member. 8/- per annum, post free. ISWL HQ, 123, Sturla Road, Chatham, Kent.

BLUEPRINTS. SWN short wave One-Valve, battery driven using DF91 valve. 1s. 8d. post free, complete with instructions. High Gain 10 Metre Converter, with a de-luxe circuit comprising EF91 RF stage, EC91 double triode mixer and oscillator, EF92 IF amplifier, with stabilised voltage supply via a 7475. 1s. 8d. post free with full instructions.

REPRINT. Converting the TR1196 Receiver. Full details on converting this unit, which may be purchased quite cheaply, into a very sensitive all-wave receiver. 6d. post free. All the above from A.S.W.P., 57, Maida Vale, London, W.9.

"GLOBE-KING" (Regd) Miniature Single Valve Receiver gets real DX—Amateur Radio enthusiasts should send for free copy of interesting literature and catalogue (enclose stamp for postage). Write to makers: Johnsons (Radio), 46 Friar Street, Worcester.

BOOKBINDING. Volumes of Radio Constructor and Short Wave News fully bound, imitation leather, gold lettering. 7s. 6d. post free. Prices for other publications on application.—Jerome Alcock, CHEADLE, Stoke-on-Trent.

Building a Televisor?

THEN CONSIDER THE FOLLOWING

RECEIVER R.1355, as specified for "Inexpensive Television". Complete with 8 valves VR65 and 1 electronic VR120, VR92, also a copy of "Inexpensive TV", ONLY 35/- (carriage, etc., 7/6). Copy of book only 2/6

I.F. STRIP 194. Another of the units specified as an alternative for the "Inexpensive TV". A first-class strip giving tremendous amplification, and well recommended for constructors who have built televisors but have come "unstuck" in the vision or sound-receiver. Complete with 6 valves VR65, and 1 each VR53 and VR92, and a copy of the book, which gives full details of conversion to both stations. Size 18 in. x 5 in. x 5 in. ONLY 45/- (postage, 2/6.)

"PYE" 45 mc/s. I.F. STRIP. Ready made for London vision channel. Complete with 6 valves EF50 and 1 EA50. ONLY 60/- (postage etc., 4/6). **RECEIVER R.3547.** This contains the "PYE" Strip, which can be easily removed if desired, and also 15 valves EF50, 3 of EB34, 2 of SP61, and 1 each EA50, EBC33, EF36, also hundreds of resistors, condensers, etc.—BRAND NEW IN MAKERS' CASES. ONLY 120/- (carriage 7/6).

Cash with order, please, and print name and address clearly.

U.E.I. CORPORATION,

The Radio Corner, 138, Gray's Inn Road, London, W.C.1. (Phone TERMINUS 7937)

Open until 1 p.m. Saturdays. We are 2 mins. from High Holborn, 5 mins. by bus from King's Cross.

NOTICES

THE CONTENTS of this magazine are strictly copyright and may not be reproduced without obtaining prior permission from the Editor. Opinions expressed by contributors are not necessarily those of the Editor or proprietors.

THE EDITOR invites original contributions on construction of radio subjects. All material used will be paid for. Articles should be typewritten, and photographs should be clear and sharp. Diagrams need not be large or perfectly drawn, as our draughtsmen will redraw in most cases, but relevant information should be included. All MS must be accompanied by a stamped addressed envelope for reply or return. Each item must bear the sender's name and address.

TRADE NEWS. Manufacturers, publishers, etc., are invited to submit samples or information of new products for inclusion in this section.

ALL CORRESPONDENCE should be addressed to Radio Constructor, 57 Maida Vale, Paddington, London, W.9. Telephone: CUN. 6518.

SUCCESS?

In Radio, Television and Electronics, there are many more jobs than engineers qualified to fill them. Because we are part of the knowledge Group we have first-hand of the needs of employers, thus our Home Study courses are authoritative and based upon modern industrial needs.

POST THIS COUPON NOW — START HERE
E.M.I. INSTITUTES, Postal Division, Dept. 179
43, GROVE PARK RD., CHISWICK, LONDON, W.4.
Please send, without obligation, your FREE BROCHURE
I have marked the subjects which interest me.

Mechanical Eng. Electrical Eng. Draughting
 Radio. Television. Production
Eng. Automobile Eng. Aeronautical Eng.
 General Cert. of Education (Metric). CIVIL Service.

Also Courses for—
A.M.I. Mech. E. A.M.I.C.E. A.M. Brit. I.R.E.
A.R. R.C. CITY and GUILDS EXAMS in
Mech. Eng., Elect. Eng., Telecommunications,
etc.

NAME _____
ADDRESS _____
E.M.I. INSTITUTES — The College backed by an Industry 17c

CLYDESDALE

Bargains in Ex-Service Equipment.

FOR INEXPENSIVE TELEVISION. INDICATOR UNIT TYPE 62, IN MAKER'S ORIGINAL CASE.

CLYDESDALE'S PRICE ONLY. £5.9.6d.

Also available in used, fair conditions. CARRIAGE PAID. CLYDESDALE'S PRICE ONLY. 79/6d. EACH CARRIAGE PAID.

E.H.T. TRANSFORMER. Primary Tapped—230-250 V. A.C. Sec. (1) 3,000 V. 3 mA. tapped 2,500 V. A.C. Sec. (2) 4 V. 1 amp. Sec. (3) 4 V. 1 amp. tapped 2.5V and 2.5V. PRICE POST PAID...45/-

MAINS TRANSFORMER. Primary Tapped—230-250 V. A.C. Sec. (1) 350-0-350 V. 160 mA. Sec. (2) 6.3V 5.A. Sec. (3) 6.3V. 6.A. Sec. (4) 5 V. 3.A. PRICE POST PAID...55/-

Also available potentiometers, resistors, condensers etc. The Data Book No. 4 (Revised and Enlarged) Each. 2/6d. Circuits for 62, R.1355, RF.24/5/16/7, R.3601. Each. 1/3d.

NEW LIST OF EX SERVICE and other items No. 8. Price 1/6d.
Price credited on purchase of 10/- value or over.

Order direct from: Tel.: SOUTH 2706/9

CLYDESDALE SUPPLY CO. LTD.

2 BRIDGE STREET, GLASGOW, C.S.
Branches in Scotland, England and North Ireland.